

The ibidi product family is comprised of a variety of μ-Slides and μ-Dishes, which have all been designed for high-end microscopic analysis of fixed or living cells.

The glass bottom versions of the μ-Slides and μ-Dishes are especially designed for TIRF, super resolution and single molecule applications. The μ-Dish 35 mm, high Glass Bottom Grid-500 allows you to perform high resolution microscopy in a 35 mm Petri-dish with 12 mm walls. The standard height allows convenient liquid handling. The lid can be closed to hinder evaporation during long term experiments.

The Grid-500 is a grid structure for relocating events on a glass coverslip, e.g. for correlative light and electron microscopy (CLEM). It provides 400 distinguishable observation squares of 500 μm edge length. The grid is clearly visible by phase contrast microscopy and imprinted into the glass coverslip.

Material

The μ-Dish 35 mm, high Glass Bottom Grid-500 is made with a glass coverslip bottom. It is not possible to detach the bottom. The μ-Dish 35 mm, high Glass Bottom Grid-500 is not autoclavable since it is temperature stable only up to 80°C/175°F.

Optical Properties ibidi Glass Bottom

Refractive index n_D	1.523
Abbe number	55
Thickness	No. 1.5H (selected quality 170 μm, ± 5 μm)
Material	Schott borosilicate glass, D 263M

Shipping and Storage

The μ-Slides, μ-Dishes and μ-Plates are sterilized and welded in a gas-permeable packaging. The shelf life under proper storage conditions (in a dry place, no direct sunlight) is listed in the following table.

Conditions	
Shipping conditions	Ambient
Storage conditions	RT (15-25°C)
Shelf Life	
Glass Bottom	36 months

Attention!

Be cautious when handling ibidi labware products with glass bottom! The glass coverslip or glass slide is very fragile and might break easily. Handle with care to avoid physical injury and damage to devices through leakage of the medium.

Geometry

Geometry of the μ-Dish 35 mm, high Glass Bottom

Diameter dish	35 mm
Volume	2 ml
Growth area	3.5 cm ²
Coating area using 400 μl	4.1 cm ²
Diameter observation area	21 mm
Height with / without lid	14 mm / 12 mm
Bottom	Glass coverslip No. 1.5H

Using The Lid

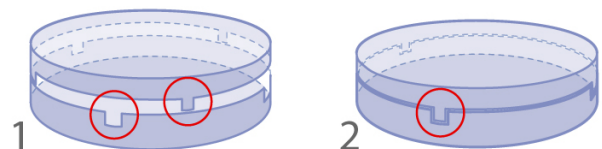

1. Open position, easy opening
2. Close position, for long term studies, minimal evaporation

Geometry of the Grid-500

Geometry of the Grid-500

Number of squares	400
Repeat distance	500 μm
Groove width	20 μm (± 5 μm)
Groove depth	< 5 μm

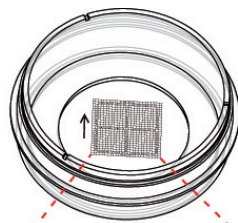

4 x 10 x 10 squares

										i b i d i																			
A	B	C	D	E	F	G	H	I	K	1	M	N	O	P	Q	R	S	T	U	1	2	3	4	5	6	7	8	9	10
1										1										1									
2										2										2									
3										3										3									
4										4										4									
5										5										5									
6										6										6									
7										7										7									
8										8										8									
9										9										9									
10										10										10									
A	B	C	D	E	F	G	H	I	K	11 <th>M</th> <th>N</th> <th>O</th> <th>P</th> <th>Q</th> <th>R</th> <th>S</th> <th>T</th> <th>U</th> <th>11<td></td><td></td><td></td><td></td><td></td><td></td><td></td><td></td><td></td> </th>	M	N	O	P	Q	R	S	T	U	11 <td></td> <td></td> <td></td> <td></td> <td></td> <td></td> <td></td> <td></td> <td></td>									
11										11										11									
12										12										12									
13										13										13									
14										14										14									
15										15										15									
16										16										16									
17										17										17									
18										18										18									
19										19										19									
20										20										20									
A	B	C	D	E	F	G	H	I	K	20 <th>M</th> <th>N</th> <th>O</th> <th>P</th> <th>Q</th> <th>R</th> <th>S</th> <th>T</th> <th>U</th> <th>20<td></td><td></td><td></td><td></td><td></td><td></td><td></td><td></td><td></td> </th>	M	N	O	P	Q	R	S	T	U	20 <td></td> <td></td> <td></td> <td></td> <td></td> <td></td> <td></td> <td></td> <td></td>									

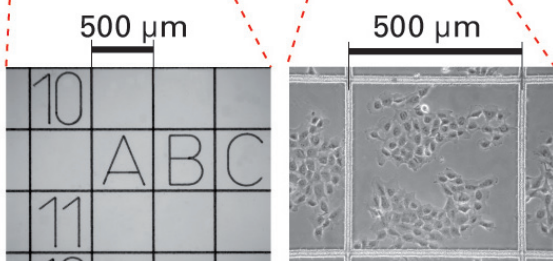

Microscopic images of the grid. Left: 4x objective lens brightfield without cells. Right: 10x objective lens phase contrast with rat fibroblast cells.

The four major squares are separated in 10 × 10 observation fields and indicated by letters and numbers ranging from:

- A to K (J not used) and 1 to 10

- A to K (J not used) and 11 to 20
- L to U and 1 to 10
- L to U and 11 to 20

Characteristics of the Grid

The Grid-500 is made of small grooves that are imprinted into a microscopy coverslip. The structure is imprinted on the side on which cells are growing. Cells and grid are in one focal plane. There is no reported effect on cell growth, coating protocols, or surface properties. Proliferation and cell behavior is comparable to standard non-gridded glass coverslips. Washing steps (e.g. with PBS) before cell seeding can remove glass dust which is advantageous for direct cell growth on the surface.

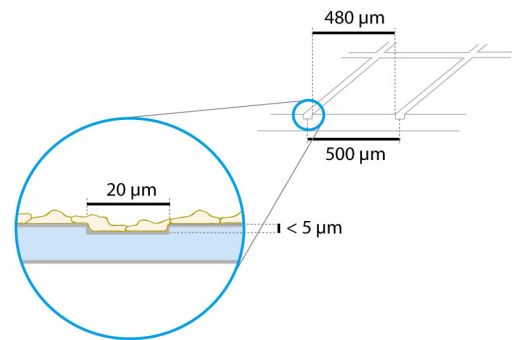

The grooves are 20 μm (± 5 μm) wide and approximately 5 μm deep. Cells can grow in the grooves as well. We recommend using objective lenses up to 20×. Anyhow, the optical quality meets the requirements of 63× and 100× oil objective lenses as well (glass coverslip bottom, No. 1.5H).

Surface and Coating

The μ-Dish ^{35 mm, high} Glass Bottom Grid-500 is manufactured with an uncoated glass coverslip. Washing steps (e.g. with PBS) before cell seeding can remove glass dust which is advantageous for direct cell growth on the surface.

Protein coatings increase direct cell growth of adherent cells. Specific coatings on glass are possible following this protocol:

- Prepare your coating solution according to the manufacturer's specifications or reference. Prepare your μ-Dish ^{35 mm, high} Glass Bottom Grid-500. Adjust the concentration to a coating area of 4.1 cm² and a coating volume of 400 μl.
- Apply 400 μl into the growth area. Make sure that the entire bottom is covered with liquid easily tilting

or shaking the μ-Dish. Put on the lid and leave at room temperature for at least 30 minutes.

- Aspirate the solution and wash. Optionally, let dry at room temperature.

Detailed information about coatings is provided in Application Note 08 "Cell culture coating".

Seeding Cells

Depending on your cell type, application of a $4-9 \times 10^4$ cells/ml suspension should result in a confluent layer within 2-3 days.

- Trypsinize and count cells as usual. Dilute the cell suspension to the desired concentration.
- Apply 400 μl cell suspension into the inner well of the μ-Dish. Avoid shaking as this will result in inhomogeneous distribution of the cells.
- After cell attachment add additionally 1.6 ml of pure medium to ensure optimal grow conditions.
- Cover the μ-Dish with the supplied lid. Incubate at 37°C and 5% CO₂ as usual.

We recommend not to fill more than the indicated total volume into the μ-Dish^{35 mm, high} Glass Bottom Grid-500 in order to avoid the liquid contacting the lid.

Undemanding cells can be left in their seeding medium for several days and grow to confluence there. However, best results are achieved when the medium is changed every 2-3 days. Carefully aspirate the old medium and replace it by up to 2 ml fresh medium.

Optional Glass Coverslip Cleaning Protocol

The μ-Dish^{35 mm, high} Glass Bottom Grid-500 is made with an uncoated glass coverslip. For improved cell attachment, glass surface modifications and other applications, the glass coverslip of the μ-Dish^{35 mm, high} Glass Bottom Grid-500 can be cleaned by following the protocol below.

- Remove lids and immerse products in ddH₂O in an appropriately sized beaker.
- Sonicate for 10 minutes.
- Decant the ddH₂O completely.
- Add 1 M HCl.
- Sonicate for 10 minutes.
- Decant the HCl completely and wash twice with ddH₂O. Decant the ddH₂O completely.

- Add 2-propanol (absolute).
- Sonicate for 10 minutes.
- Aspirate the 2-propanol completely. Make sure that all products are completely dry. Wash twice with ddH₂O and aspirate the ddH₂O completely.
- Add ethanol (absolute).
- Sonicate for 10 minutes.
- Aspirate the ethanol completely. Make sure that all products are completely dry. Wash twice with ddH₂O.
- Sonicate in ddH₂O for 10 min.
- Decant ddH₂O and blow dry carefully with canned air or clean nitrogen gas.

Modifications of this protocol including acids, bases, alcohols and detergents are possible. Please check the chemical compatibility list on www.ibidi.com for compatibility. Make sure to handle the glass-bottomed products with care. The glass coverslips may break during mechanical handling. For best results, use a custom-made Teflon holder.

Tip:

You can stack the μ-Dishes to save space in your incubator. This will not affect cell growth. We recommend making batches with up to 6 μ-Dishes, due to stability reasons. Placing the μ-Dishes into larger Petri dishes simplifies transport and prevents evaporation, heat loss, and contamination when the incubator is opened.

Cell Microscopy and Solvents for Fixation

To analyze your cells, no special preparations are necessary. Cells can be observed live, or fixed directly in the μ-Dish^{35 mm, high} Glass Bottom Grid-500, preferably on an inverted microscope. Due to the thin bottom, high resolution microscopy is possible. The material is compatible to most fixatives, like acidic acid, alcohols and PFA. For a full list of compatible solvents and more information on chemical compatibility, please visit the FAQ section on www.ibidi.com. For optimal results in fluorescence microscopy and storage of stained probes ibidi provides a mounting medium (50001) optimized for μ-Dishes and μ-Slides.

Immersion Oil

When using ibidi Glass Bottom products with oil immersion objectives, there is no known incompatibility with any immersion oil on the market. All types of immersion oils can be used.

Minimizing Evaporation

Using the μ-Dish with a closed lid, the evaporation in an incubator system with 37°C and 95% humidity is around 1% per day. Using the μ-Dish with a closed lid in a 37°C heating system with low humidity (between 20% and 40%), the evaporation is around 10% per day. For reducing the evaporation down to 1% per day in all systems, we recommend sealing the lid with ibidi Anti-Evaporation Oil (50051).

Selected References

- H.-Y. Hsieh, T.-W. Huang, J.-L. Xiao, C.-S. Yang, C.-C. Chang, C.-C. Chu, L.-W. Lo, S.-H. Wang, P.-C. Wang, C.-C. Chieng, C.-H. Lee, and F.-G. Tseng. Fabrication and modification of dual-faced nano-mushrooms for tri-functional cell theranostics: SERS/fluorescence signaling, protein targeting, and drug delivery. *Journal of Materials Chemistry*, 2012.
- D. M. Seiler, J. Rouquette, V. J. Schmid, H. Strickfaden, C. Ottmann, G. A. Drexler, B. Mazurek, C. Greubel, V. Hable, and G. Dollinger. Double-strand break-induced transcriptional silencing is associated with loss of tri-methylation at H3K4. *Chromosome Research*, 2011. doi: 10.1007/s10577-011-9244-1.
- S. Stoppelkamp, H. S. Bell, J. Palacios-Filardo, D. A. Shewan, G. Riedel, and B. Platt. In Vitro Modelling of Alzheimer's Disease: Degeneration and Cell Death Induced by Viral Delivery of Amyloid and Tau. *Experimental Neurology*, 2011. doi: 10.1016/j.expneurol.2011.01.018.
- P. Weinmeister, R. Lukowski, S. Linder, C. Traidl-Hoffmann, L. Hengst, F. Hofmann, and R. Feil. cGMP-dependent Protein Kinase I Promotes Adhesion of Primary Vascular Smooth Muscle Cells. *Molecular Biology of the Cell*, 2008. doi: 10.1091/mbc.E08-04-0370.

μ-Dish 35 mm Grid Family

μ-Dish 35 mm, high Grid-500

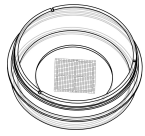

Cat. No.	Description	Characteristics
81166	μ-Dish 35 mm, high ibiTreat Grid-500 : ø 35 mm, high wall (2 ml volume), #1.5 polymer coverslip, tissue culture treated, grid repeat distance 500 μm	hydrophilic, sterilized
81161	μ-Dish 35 mm, high Uncoated Grid-500 : ø 35 mm, high wall (2 ml volume), #1.5 polymer coverslip, grid repeat distance 500 μm	hydrophobic, sterilized

μ-Dish 35 mm, low Grid-500

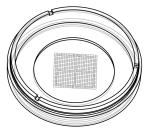

Cat. No.	Description	Characteristics
80156	μ-Dish 35 mm, low ibiTreat Grid-500 : ø 35 mm, high wall (800 μl volume), #1.5 polymer coverslip, tissue culture treated, grid repeat distance 500 μm	hydrophilic, sterilized
80151	μ-Dish 35 mm, low Uncoated Grid-500 : ø 35 mm, high wall (800 μl volume), #1.5 polymer coverslip, grid repeat distance 500 μm	hydrophobic, sterilized

μ-Dish 35 mm, high Glass Bottom Grid-500

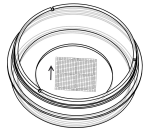

Cat. No.	Description	Characteristics
81168	μ-Dish 35 mm, high Glass Bottom Grid-500 : ø 35 mm, high wall (2 ml volume), #1.5H (170 ±5 μm) D 263 M Schott glass, grid repeat distance 500 μm	sterilized

μ-Dish 35 mm, high Glass Bottom Grid-50

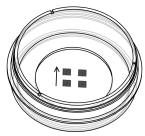

Cat. No.	Description	Characteristics
81148	μ-Dish 35 mm, high Glass Bottom Grid-50 : ø 35 mm, high wall (2 ml volume), #1.5H (170 ±5 μm) D 263 M Schott glass, grid repeat distance 50 μm	sterilized

For research use only!

Further technical specifications can be found at www.ibidi.com. For questions and suggestions please contact us by e-mail info@ibidi.de or by telephone +49 (0)89/520 4617 0. All products are developed and produced in Germany.
© ibidi GmbH, Am Klopferspitz 19, 82152 Martinsried, Germany.