

ZEBRAFISH

SYSTEMS



Fast, automatic analyses



Wide-scale evaluation possibilities (averaged EKG, QT, QTv, HRV)

Social interaction examinations



Measurements of locomotor activity (LMA)

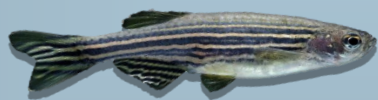

Accumulated voltage response (AP) measurement

Analyze extra-, and intracellular potentials

CardioFish

For the examination of the heart function of adult zebrafish

PsychoFish

For quantitative monitoring and analyzing of group behaviour

CellFish

For the AP measurement of the embryonic and adult zebrafish heart ion channels

The zebrafish (*Danio rerio*) examination systems of the MDE GmbH are supporting the methodological background of the physiological, pharmacological and toxicological researches on the fields of cardiovascular and group behavior, on the highest measurement technical and data processing level possible.

CARDIOFISH

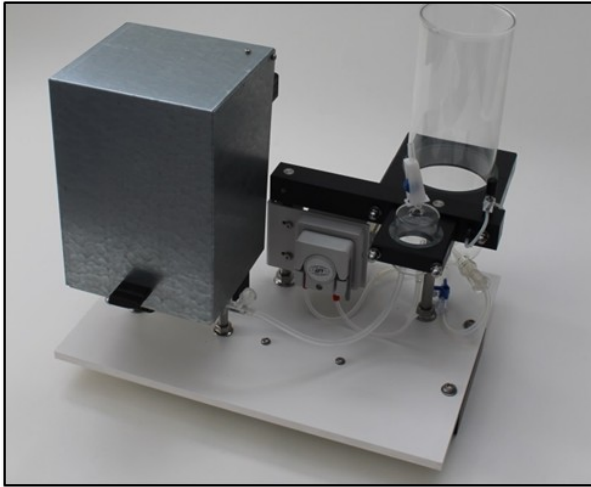

The **CARDIOFISH** system is the latest development of the MDE GmbH, which provides an opportunity to examine extra- and intercellular heart functions of the adult zebrafish. The system can be effectively used to examine the effects and side-effects of candidate medicine molecules on the fields of pharmacology, safety pharmacology and toxicology. It is highly applicable in the basic research of arrhythmia and the regenerative abilities of the heart muscle.



PSYCHOFISH

Nowadays besides using conventional mammal species, the zebrafish became an equally important laboratory animal. Apart from its intensively popular cardiovascular usage, this species can also be efficiently used for on the field of neural and psycho-physiological/ pharmacological basic- and applied researches. On the grounds of this knowledge, our business developed the **PSYCHOFISH** measuring system. This system is suitable for monitoring group behaviour.



CellFish



The MDE GmbH has been successful for years with its workstation specially designed for the **standard microelectrode technique**. This was further developed for the accumulated voltage response (AP) measurement of the embryonic and adult zebrafish heart ion channels.



MEASURING SYSTEM

The system, which was developed for a detailed electrophysiological heart examination of the zebrafish, consists of the next three main units:

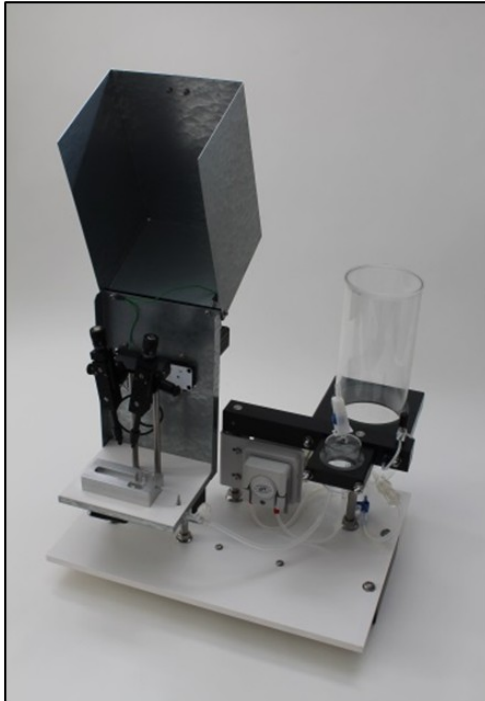

- Mechanical unit
- Low-noise broadband analogue amplifier
- Data visualizing, - archiving and –evaluating hardware/software

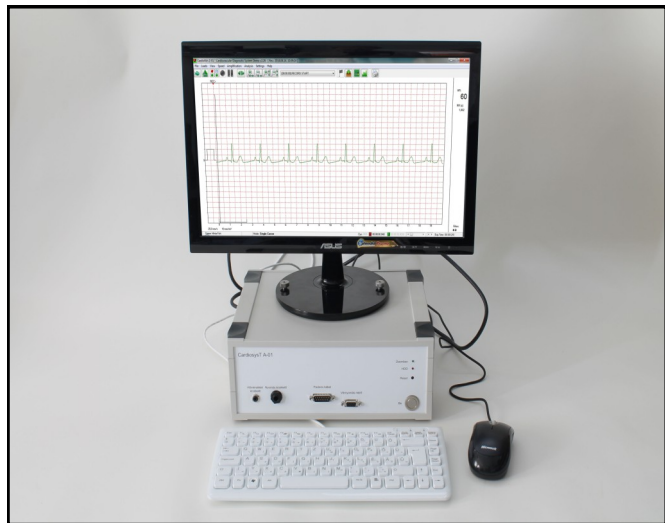

While designing the system, we laid stress on its ability to be easily assembled. On the grounds of this, a workstation was created, which makes the learnability and usability of the system significantly easier.

The vibration-free object table is holding the two main units of the system (the mechanical unit and the broadband amplifier). The Faraday cage, which is connected to the table, carries the broadband amplifier on its backside. The fish tub and the two 0,5mm pitch manipulators, which are containing the electrode holder sleeve (electrodes; stainless steel, glass electrode), are also on the table. The manipulators can be horizontally adjusted.



MEASURING DATABASE

The system contains the **Cardiofish Z-01 software**, which has an inbuilt database surface, where all the measurement results are automatically stored. The database can be opened with the quickbutton, or with the appropriate order of the menu.



The measurement results are placed under the measurement **entity**, while each measurement **entity** can be arranged into groups.

The panel makes it possible to record data of new **entity** or to select a previously recorded species for new measurements. Besides, it is also applicable to restore previous measurement files, so that these can be verified and evaluated again any time.

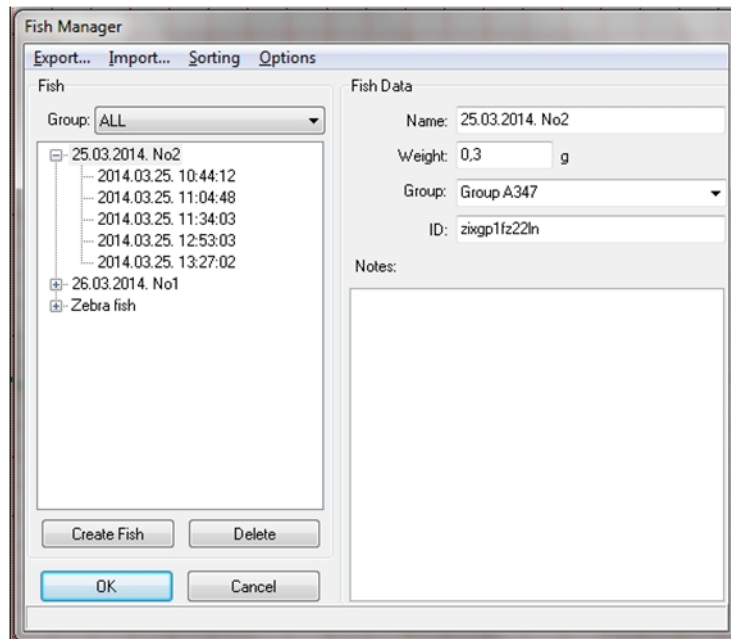

EKG RECORDING

For EKG recordings both the quickbuttons above the monitoring field and the roll down orders of the menu can be applied. By the means of these buttons, the applied filter visualization or the appearing visual parameters of the EKG curve can be altered (eg.: amplification, speed), the notes belonging to the measurements can be recorded, respectively the recording process can be started or stopped.

Signal display can be adjusted by setting the width of the time window and amplification display factor. The optimization of filter effects (50 or 60 Hz notch filter, high-pass baseline filter (removing breath-related baseline oscillations) and low-pass high frequency rejection filter) is aided by visualizing superimposed raw and filtered signals. User can place time labels with comments along the recording session, making it easier to retrieve sections of interest for off-line analysis.

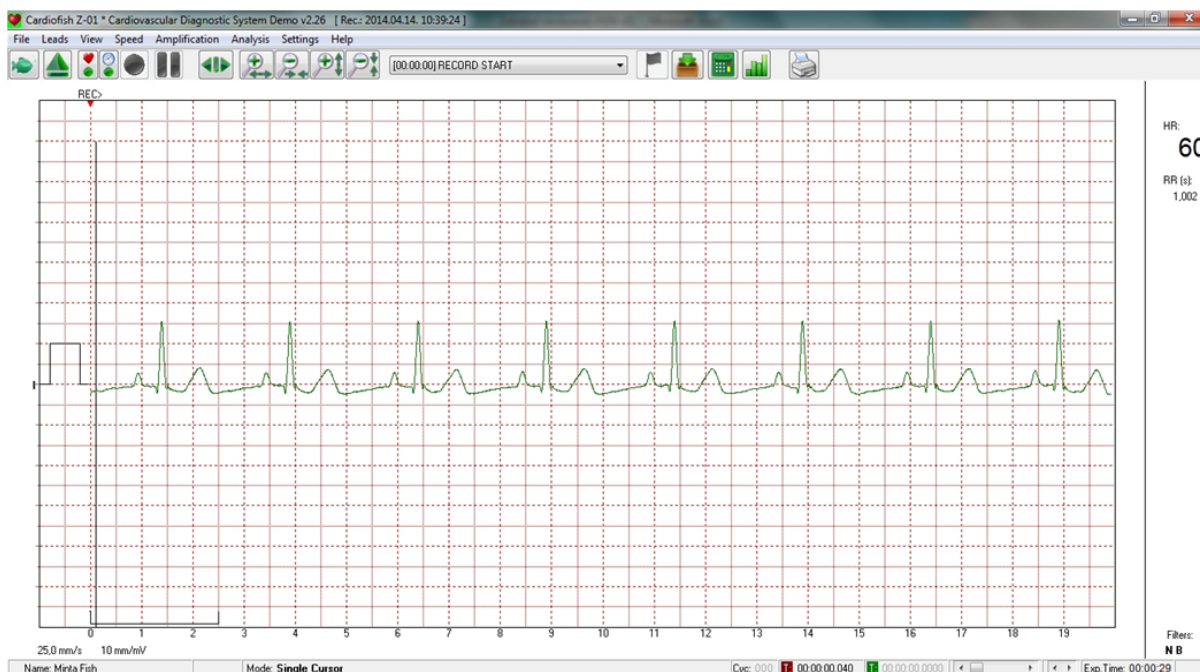

OFFLINE ANALYZATIONS

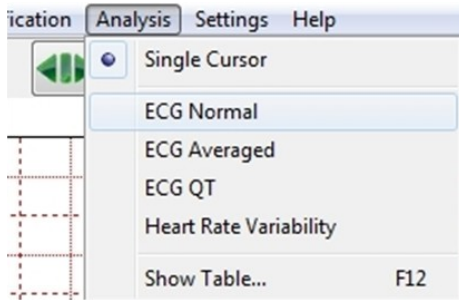

The recorded EKG curves can be either evaluated right after the measurements or any time later. The software provides five different possibilities for that. The most typical EKG parameters can be quickly calculated, however, owing to the wide choice of analyses, even more complex features can be analysed.

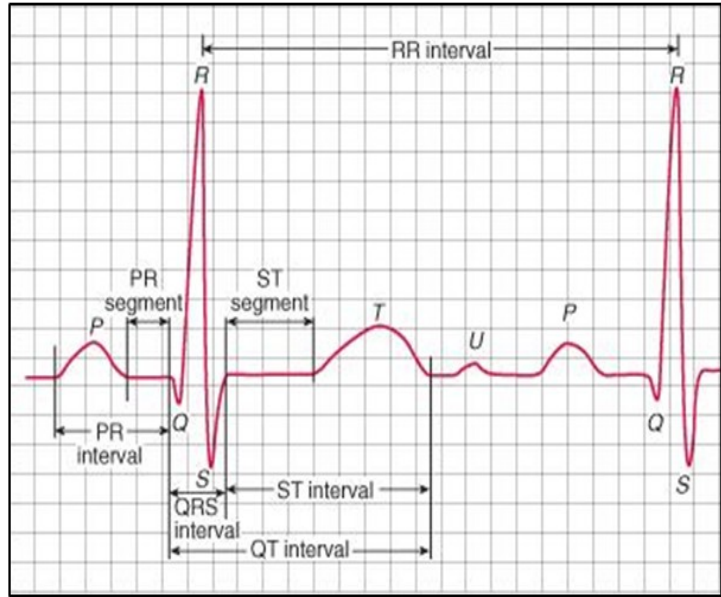

1. One cursor analysis: can be applied to collect the amplitudes, belonging to the points signed by the cursor on the EKG curve, and HR values into a chart.

Analysis - Manual

Export... Print! Delete!

Single Cursor

Memo	Time	Lead	A (mV)	HR (bpm)	S..	D..	T...
	00:00:01.061	I	0,013	237	0	0	0,0
	00:00:01.495	I	-0,069	233	0	0	0,0
	00:00:02.019	I	-0,020	233	0	0	0,0
	00:00:03.039	I	0,054	115	0	0	0,0

2. ECG normal analysis: evaluating the EKG with automatic parameter measurements, from any single optional cycle chosen by the user.

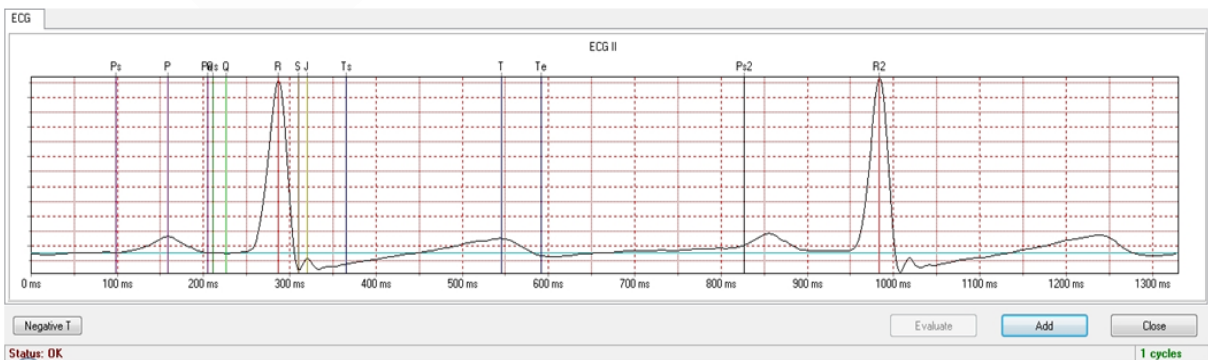

3. EKG averaged analysis: evaluating the EKG with automatic parameter measurements, from any optional phase (cycle) chosen by the user.

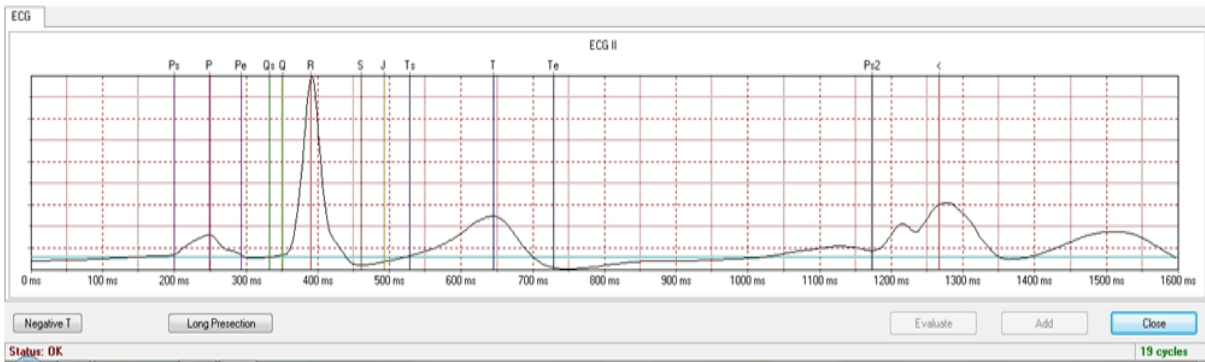

4. EKG QT analysis: calculating an eligible QT or QTc value, as well as QT variability (QTv) as a function of RR or HR, in case of at least 32 chosen cycles.

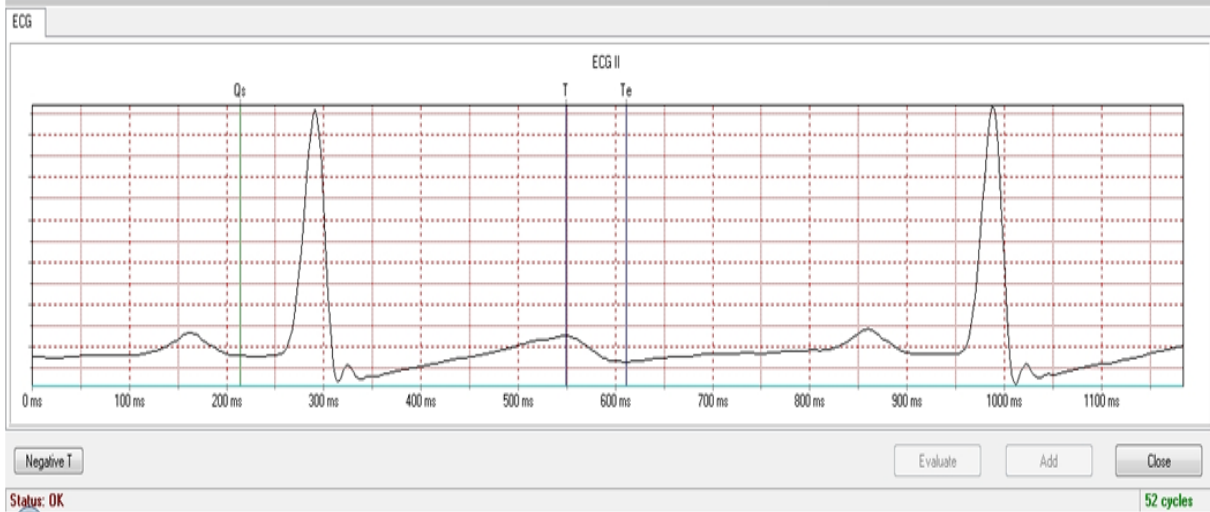
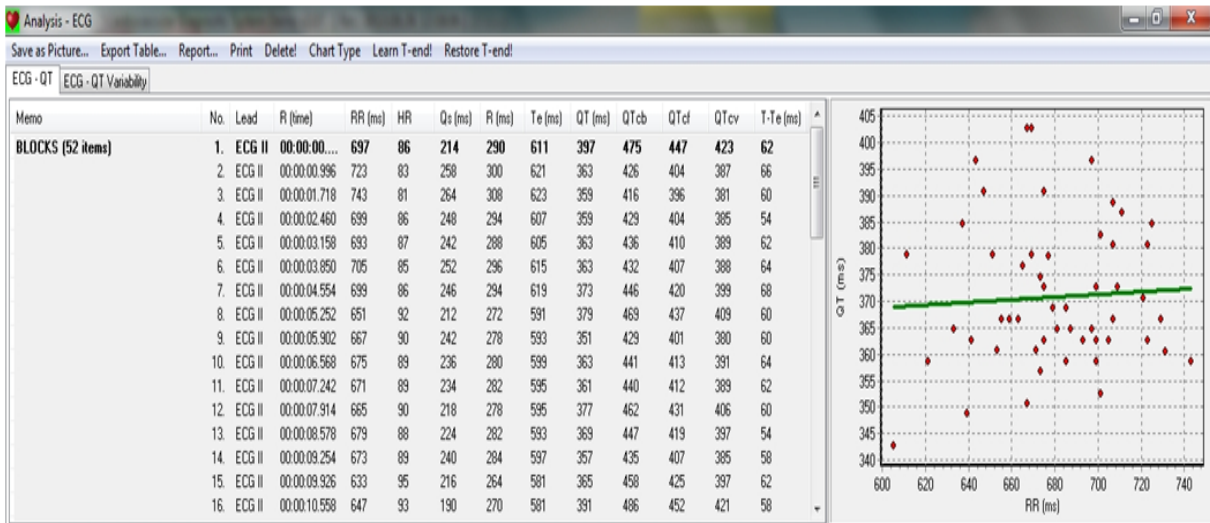

5. Heart frequency variation (HRV) analysis: The analysis of the variation of heart frequency with time and frequency domain analysis, and a possibility of RR normalization.



TECHNICAL DATAS

Electronical parameters

Running programmes on Windows based 64 bit operating system
Making single-channel recording
Visualizing and recording real-time curve
Screen running time: 5, 10, 25 or 50 mm/sec
Persistent EKG monitoring with heart frequency display
A.C. network noise-filtering algorithm (50/60Hz)
Muscle movement (vibration, tremor) filtering algorithm
Sampling frequency: 1000 sample/sec
Amplification: 10000x
Input impedance: 1000Ω @ 1kHz
Input resistance: 10kΩ

Mechanical parameters

Overall dimension: 400x300x350 mm
Manipulators 0,05 mm /revolution/25 mm
Size of fishbath:20 ml
Overall dimension of fishbath: 90x40x20 mm
Material of fishbath: anodized aluminium

HOW CAN THE SYSTEM HELP

The CardioFish measuring system, a highly integrated workstation, designed and developed by our company is suitable for the measurement of spontaneous or affected cardiac responses on adult (at least 3 months old) species. The mechanics, the sensor the low-noise broadband amplifier and the data displaying, storing and analyzing software form a harmonious unit in the system.

The design of the measuring unit was based on the fact that ion channels defining the operation of the heart show partial similarity between human and zebra fish. This mechanism results in a nearly similar monophasic potential (MAP) measurement to the human ECG.

What does the zebrafish heart has in common with the human heart?

- heart rate,
- connection between QT and heart rate,
- the shape of the action potential (MAP): the Na wave/power is liable for fast depolarization, L-type Ca channel is liable for the long plateau phase and IKr plays a role in repolarization,
- there is an acetylcholine-activated K (KAch) channel,
- pharmaceuticals, which lengthen the QT phase in human therapy also result in a lengthened QT phase in case of zebra danios (this feature is a characteristic of adults and embryos as well),
- in case of KCNH2 (IKr channel) mutation the action potential of the heterozygote fish lengthens, while in case of wild species, a small concentration of dofetilide does not result in any significant change.

How does the zebrafish heart differ from the human heart?

- no IKs,
- many T-type Ca channel in the atrium and the ventricle,
- no I_{to1} or I_{Kur} ,
- smaller I_{Na} density.

How does the system work:

When designing the system a fundamental requirement was to ensure the stability of parameters of animal physiology and the objectivity of measurement.

The following picture represents the operation of the system:

- The liquid enriched with gas goes through the **G1** and **G2** buffer tank through switch tap **A**, roller pump **B**, elastic vessel **C**, bubble remover chamber **D** and cannula **E1** before reaching the laboratory animal.
- The laboratory animal is placed on a sponge foam in bath **E**, which also keeps the body continuously wet. The excess liquid returns to tank **G** through the outlet and switch tap **F**.
- The gas supply of the tanks is provided through valve **J1** and **J2**.

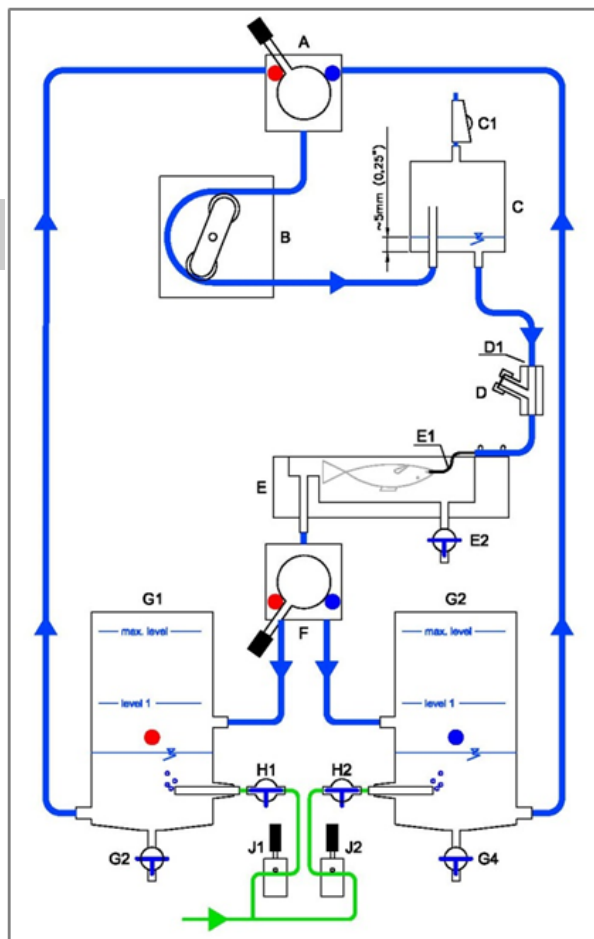

Unique technical solutions:

One of the strengths of the system is the possibility of electrode positioning, which is ensured by the flexibly adjustable mechanics, the manipulators, which can be positioned in any level of the space and a vertically adjustable object table.

Manipulator positioning:

The manipulators are in the centre of the measuring block, with which the stainless steel electrodes can be inserted into the examined laboratory animal. The manipulator sting can be finely adjusted not just on the **X (stabbing) plane**, but also on Y and Z axis. The **Y (electrode applicator) plane** movement helps to apply the electrodes in the electrode sleeve, where the ball joint design allows free circular movement. The free **Z (positioning) plane** movement helps to apply the optimal stabbing position.

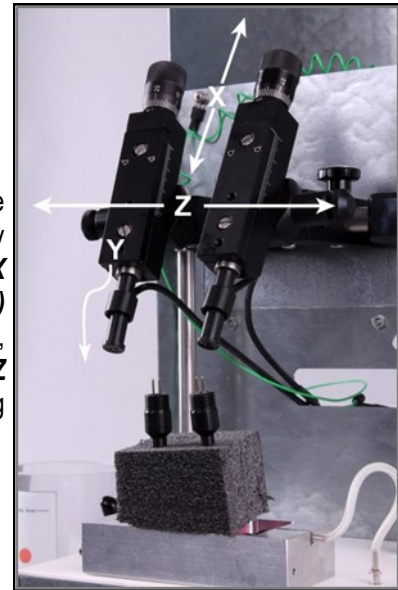

Measuring block positioning:

The block can be vertically moved on the rods fixed to the table. The position can be stabilized with the lever located on the left hand-side. The large scale adjustment of the measuring block facilitates cleaning, the placement of the species in the bath, the electrode replacement or the settings when applying a longer electrode.



Electrode connection:

The electrodes can be connected to the system when the manipulators are unfolded. After connection the electrode vessel can be fixed with its purpose-made hollander. This allows the use of any other type of electrode, as long as this information is available when the device is manufactured.



Further possibilities of application:

Drug injection:

1. The E₁ cannula connection allows direct drug injection into the gas-enriched liquid, which is lead to the experimental subject.



2. External drug injection units can also be used (e.g.: MAN-07 precision manipulator, WPI Nanoliter 2010 pump, etc.) which help to inject the drug into body cavities or tissues.



Intracellular measuring option:

The mechanical design of the systems (e.g.: vibration-free adjustable object table, special manipulators, variable electrode sleeve, etc.) allows intracellular measurements in the zebra danio embryo. We provide the amplifier (EXP-INT-01), electrostimulator (EXP-ST-A1), and electrode sleeve (WPI MEH micropipette), which are necessary for the measurement.



Methodological assistance

An integral part of our company philosophy is to continuously follow-up the sold products, provide fast service and methodological trainings. Trainings can be organized in the following conference places:

Institute	Place	User
INSERM, EA 4612 Neurocardiology, Physiopathology of the disorders of the heart rhythm	Lyon, FRANCE	Georges Christé, PhD
Szent Istvan University, Department of Aquaculture	Gödöllő, HUNGARY	Béla Urbányi, PhD

PSYCHOFISH

MEASURING SYSTEM

The system, which was developed for monitoring the group cohesion (social interaction) and movement intensity (locomotor activity) of the zebrafish, consists of the next three main units:

- Mechanical unit
- Image recording unit
- A Hardware/software storing, visualizing and evaluating the image sequence

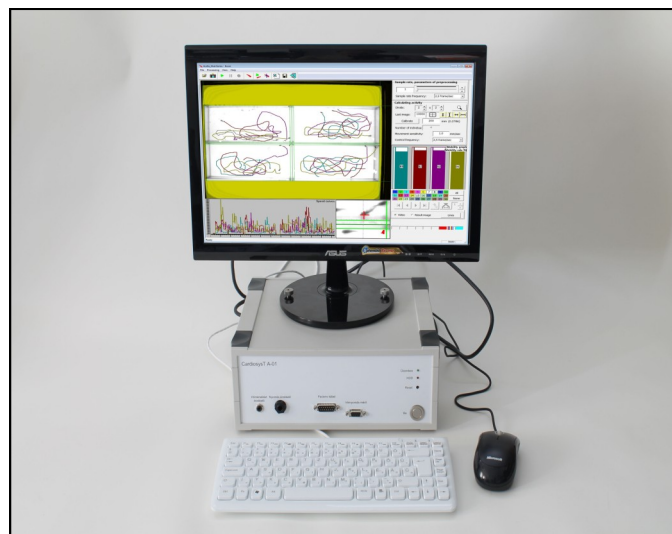

While designing the system, we laid stress on its ability to be easily assembled. On the grounds of this, a workstation was created, which makes the learnability and usability of the system significantly easier. An 1260x500x1250mm anodized aluminium frame is providing the basis of the mechanical unit, which includes the pool holding plate. This plate is made of white opal plexi, which provides an even light-distribution. The power supply unit, which insures the power supply of the lighting, is placed in the frame. The emphasized service of the system is that **provides a possibility for two different arrangements of lighting**, which allows a wider range of methodical application:

- Lower lighting with white background lighting
- Upper infra lighting

The infra lighting and the image recording unit are positioned on the horizontal level of the vertical aluminium frame. Both components can be adjusted on its own level. On the pool holding plate optimally 4 pieces of 100x200x50 mm fish pools can be placed.

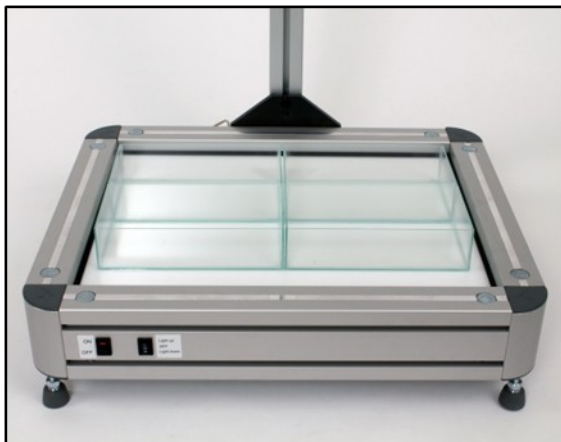

The **KOMI** image evaluating program, belonging to the measurement systems, is made for the objective monitoring of **group cohesion (social interaction)** and **movement intensity (locomotor activity)** of the zebrafish, which provides an opportunity to process and evaluate previously recorded (image sequences). The two different measurements are controlled by two different programme branches.

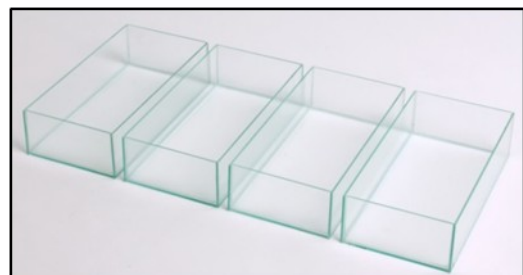

EXAMINING GROUP COHESION (SOCIAL INTERACTION)

When measuring the social interaction of offsprings, one have to take into consideration the space need, water depth, entity- and group sizes, which are necessary for the normal behaviour of the zebrafish. Owing to that, the fish are examined in a 20mm water depth. During the measurements, a digital video recording is made of the movement of the entities, which is processed by the **Komi** programme branch. This software function is available through the related icons.



After entering the programme the main screen shows up with the recorded image sequence. The recording can be calibrated by means of the controlling panel on the right side of the screen, as well as setting the exact length of the pool and the number of fish.

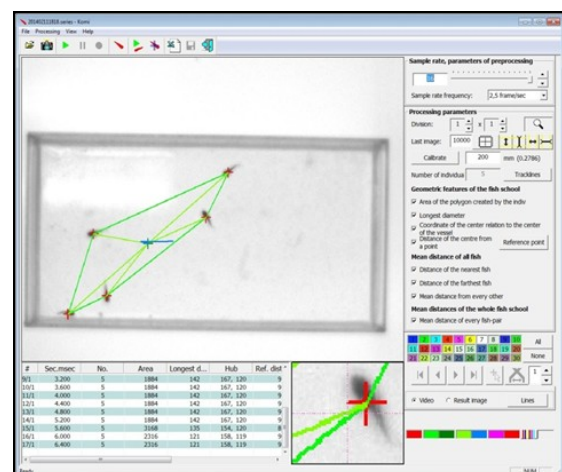
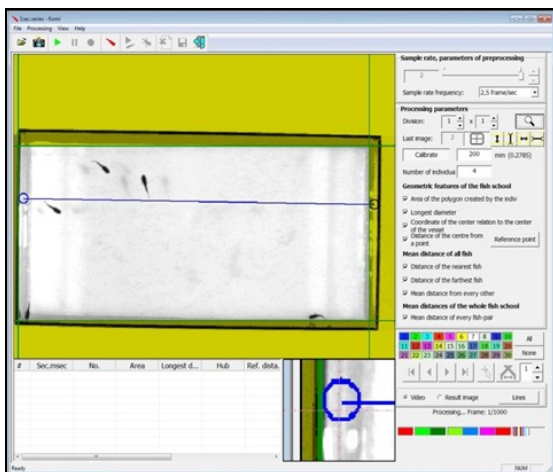

20140415153347 [kompatibilis üzemmód] - Microsoft Excel

Number	Individual	Area (mm)	Longest d	Hub	Ref. dista	Mean min	Mean ma	Average	Mean dist	Positions ... repeatedly
1	1	5	2691	136	172	120	104	36	111	72 72 255 189 236 165 163 143 210
2	1	5	2691	136	172	120	104	36	111	72 72 255 189 236 165 163 143 210
3	1	5	2691	136	172	120	104	36	111	72 72 255 189 236 165 163 143 210
4	1	5	2691	136	172	120	104	36	111	72 72 255 189 236 165 163 143 210
5	1	5	2691	136	172	120	104	36	111	72 72 255 189 236 165 163 143 210
6	1	5	2691	136	172	120	104	36	111	72 72 255 189 236 165 163 143 210
7	1	5	2691	136	172	120	104	36	111	72 72 255 189 236 165 163 143 210
8	1	5	2691	136	172	120	104	36	111	72 72 255 189 236 165 163 143 210
9	1	5	2691	136	172	120	104	36	111	72 72 255 189 236 165 163 143 210
10	1	5	2691	136	172	120	104	36	111	72 72 255 189 236 165 163 143 210
11	1	5	1884	141	166	120	98	37	114	72 72 252 188 225 171 160 141 203
12	1	5	1884	141	166	120	98	37	114	72 72 252 188 225 171 160 141 203
13	1	5	1884	141	166	120	98	37	114	72 72 252 188 225 171 160 141 203
14	1	5	1884	141	166	120	98	37	114	72 72 252 188 225 171 160 141 203
15	1	5	1884	141	166	120	98	37	114	72 72 252 188 225 171 160 141 203
16	1	5	1884	141	166	120	98	37	114	72 72 252 188 225 171 160 141 203
17	1	5	1884	141	166	120	98	37	114	72 72 252 188 225 171 160 141 203
18	1	5	3168	135	154	120	86	38	112	72 72 236 188 236 188 236 188 236
19	1	5	2316	121	158	119	89	27	104	67 67 154 152 232 186 154 152 219

The software automatically performs the graphical and numerical processing of the video recording, while it also determines distance and area values. During the evaluation, the software realizes the position of the fish, and marks them with white crosses. The number of recognized fish appears of the screen, and the alteration of the area of the polygon (one of the index-number of the group cohesion, that contains the shoal, can be monitored, while the orbit line of the geometrical midline of the group stands out.

During the processing, the calculated data is put into an Excel table:

- Area of the bounding polygon
- Longest diagonal of the bounding polygon
- Coordinates of the centre of gravity of the bounding polygon (compared to the middle of the pot)
- Distance of the centre of gravity of the bounding polygon from a reference point.
- Distances averaged to all the fish: distances measured from the closest fish, distance measured from the farthest fish, and distance measured from all the other fish.
- Average of the distance of all the fish pairs.



EXAMINING MOVEMENT INTENSITY (LOCOMOTOR ACTIVITY)

When measuring the social interaction of offsprings, one have to take into consideration the space need, water depth, entity- and group sizes, which are necessary for the normal behaviour of the zebrafish. Owing to that, the fish are examined in a 20mm water depth, in maximum 4 pools. During the measurements, a digital video recording is made of the movement of the entities, which is processed by the **KomiM** programme branch. This software function is available through the related icons.



After entering the programme the main screen shows up with the recorded image sequence. The recording can be calibrated by means of the controlling panel on the right side of the screen, as well as setting the exact length and partition of the pools and the number of fish.

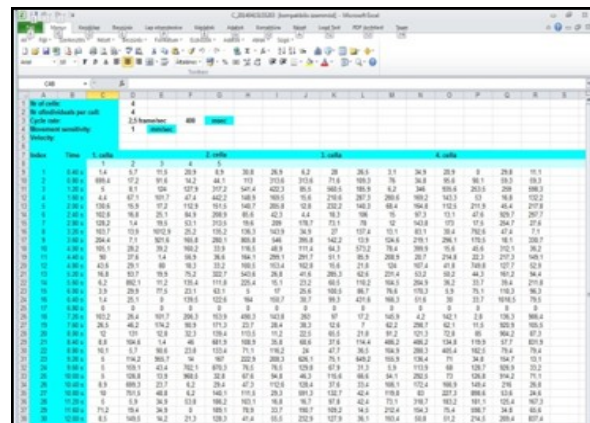
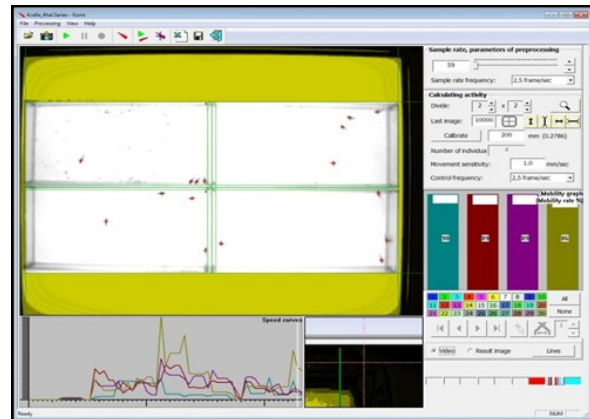
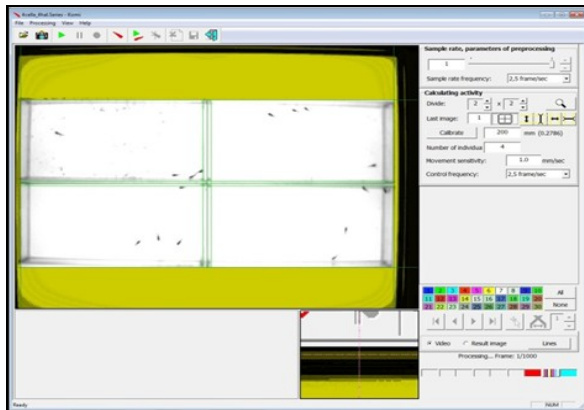

As a consequence of that, the software automatically performs the graphical and numerical processing of the video recording. The programme automatically realizes the position of the fish, and marks them (with colourful crosses). The number of recognized fish appears, and the orbit line of their movement stands out. Moreover the movement speed and the length of the covered distance of all the fish is calculated, which are put in an Excel table.

TECHNICAL DATAS

Overall dimension: 1260x500x1250 mm
Size of pool holder plate: 450x350
Material of pool holder plate: opal plexi
Size of the pool: 200x100x50 mm
Material of the pool: glass
Height of camera holder: maximum 900 mm (adjustable)
Lower lighting: 12V DC/25W
Infra lighting: 12V DC/8W
Camera: monochrome DMK 23G274 HF 12.5 with optics

HOW CAN THE SYSTEM HELP?

The PsychoFish measuring system was developed and manufactured by our company to test behavioral patterns on adult (3 months old) and juvenile (1-2 months old) species. The developed measurement system is a highly integrated workstation, which contains mechanics, optics and a data display-, storage- and evaluating-software. The product was designed to test two fundamental group behaviors, the analogies of which can also be found in human behavior patterns:

- **Social interaction**
- **Locomotor activity**

Methodological background

The measuring system is based on the zebrafish (*Danio rerio* or *Brachydanio rerio*) model. The selection of the species was influenced by the fact that social life is regarded to be highly widespread among fish, as well as that lifelong group formation is the characteristic of a quarter of fish species (zebrafish belongs to this quarter).

In the zebrafish research social behavior primarily means group formation, the social attraction and the regulation of distancing from peer. The importance of this is not so much the topic of biological curiosity, but the fact that a phenomenon which is relatively easy to examine (social attraction to peers), fish serve as a well-testable model even to human physiological, genetic and neurological research. Zebrafish became a popular experimental animal because of their relatively simple nervous system, well-known genome, and last but not least the strict animal welfare regulation of the different invasive and lethal interventions. To test group formation, in recent years a method has been developed, which combines the easily-manipulated fish behavior with a high degree of automation of data collection and analysis. Neurological researches carried out on the species are also significant, such as **lateralization** (the research of such neurological and neuroethological phenomena, which show a characteristic left-right separation on the expression level) (Halpern et al. 2003).

Neurophysiology techniques (the definition of quantity of certain **neurotransmitters** after the removal of the brain of the fish) revealed interesting relationships between the timing of group formation and the amount of certain neurological mediating materials. It turned out that in case of the *Danio rerio*, they are primarily the dopamine and dopamine-like neurotransmitters, which show a similar increasing production during ontogenesis, as well as an increasing tendency to form groups (Buske and Gerla, 2012). However, group formation tendency ceases in case of adult fish treated with dopamine D1 receptor blocking drug (vision and mobility, as well as other behaviors remain intact (Scerbina et al. 2012)). **The relationship between dopamine system and social behavior** was confirmed by the discovery, which was based on the differences found in the

zebrafish lines. It turned out that in case of phylum coded ' AB ', group formation tendency continues to grow during ontogenesis, while there is a sudden change in case of phylum coded ' TU ' between the ages of 25 and 50 days. Investigating the presence of neurotransmitters in the brain of the fish in the questioned period it turned out that while dopamine concentration shows a linear increase in case of phylum coded ' AB ', the dopamine level increases shows a sudden increase in case of phylum coded ' TU ' during the development of the species (Scerbina et al., 2012).

Unique technical solutions supporting the measurement

The mechanical and the imaging elements of the measuring system can be used in both studies (social interaction and locomotor activity).

The system, which is capable of measuring the **social interaction** and **locomotor activity** of the fish offspring takes into account the space and water depth requirements required for normal behavior, and the species and group sizes.

Examination pools with white background bottom lighting and top infrared lighting allows a wider range of methodological application. Any selected mechanism allows glint-free lighting. As a result of that the movement of the fish can be easily followed.

The background of the examinations is provided by the two branches of the KOMI software. In both cases the software uses the same algorithm to handle sequences capture, display, but there are substantial differences in the analysis.

This means that the user can quickly learn the necessary management skills and the purchasing costs of the necessary testing equipments are also reduced.



Other potential applications

An essential assistance to obtain further information is that “**dopamine-like transmitters**”, which trigger action, can also be examined in vitro. Our company can offer the **NEU-04** release superfusion system to conduct the investigation.

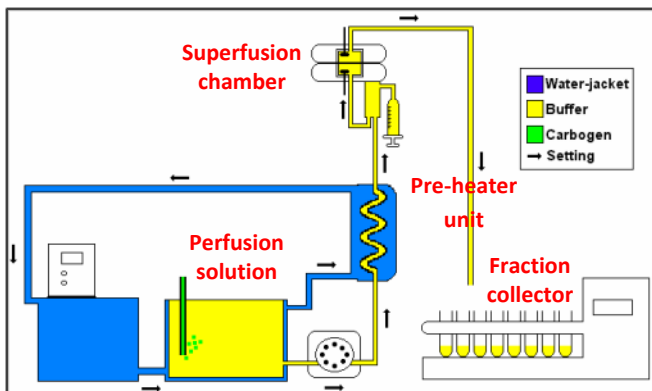

Methodological assistance

An integral part of our company philosophy is to continuously follow-up the sold products, provide fast service and methodological trainings. Trainings can be organized in the following place:

Institute	Place	User
Szent Istvan University, Department of Aquaculture	Gödöllő, HUNGARY	Béla Urbányi, PhD

CellFish

The MDE GmbH has been successful for years with its workstation specially designed for the **standard microelectrode technique**. This was further developed for the accumulated voltage response (AP) measurement of the embryonic and adult zebrafish heart ion channels.

The workstation consists of the following units:

1. Mechanical unit,
2. Measuring system:
 - High input impedance, low noise amplifier (INT-01),
 - Data displaying, storing and analyzing hardware/software (EASY-CEL).



1. Mechanical unit

Its base is a highly stable, vibration-free desktop, which has all the glass technical elements that are necessary to keep alive the heart dissection of the adult and embryonic species.

Each unit and their functions are presented in the following figures.

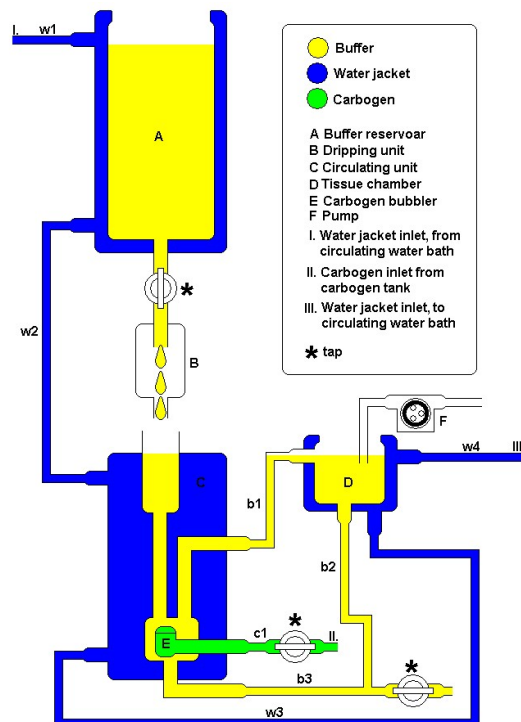
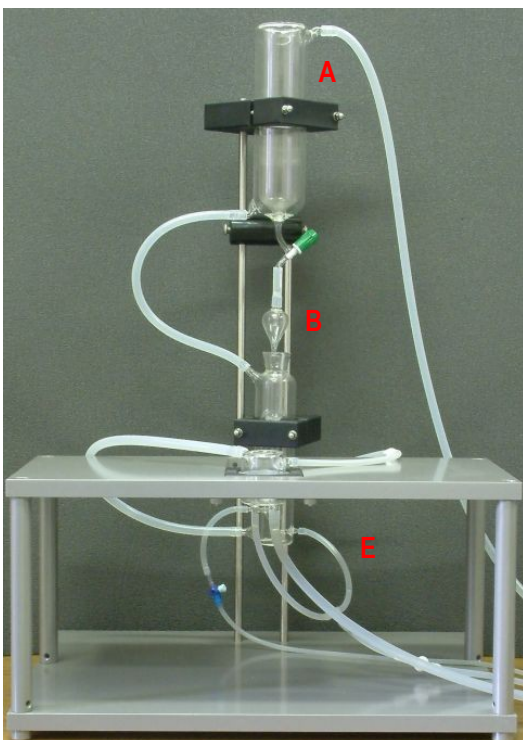

The organbath modes for adult for fish heart dissection

Open circuit

the saline solution constantly flows in the organ chamber and the maintenance of the proper fluid level is provided by pump suction.

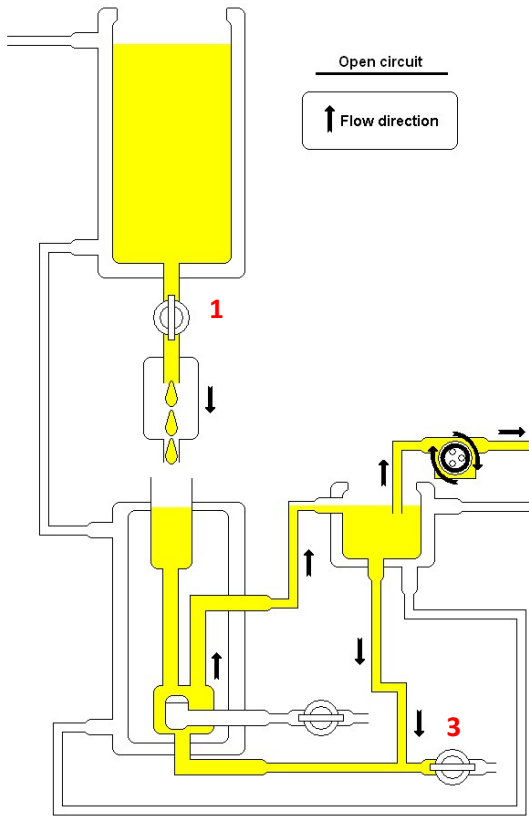

Closed circuit

the flow of the saline solution is suspended: tap 1 closed, tap 3 opened, pump stopped. The solution is added to the organ.

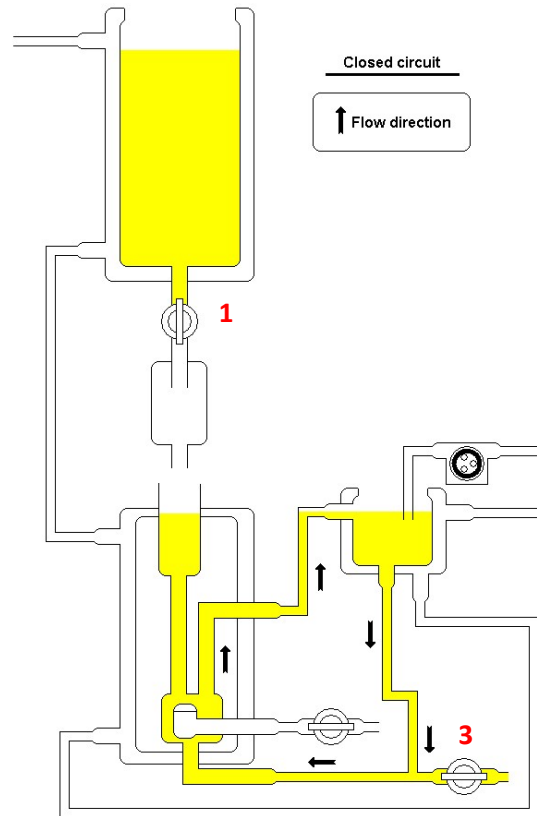

The setup of equipment necessary for the experiment

One of the advantages of the mechanical design of the system, is that the equipment necessary for the measurement (pl.: manipulators, organbath, lighting, etc.) can be arranged in the upper side of the bench in the most convenient position. Another advantage is that the organbath can be changed to fit any species in the slot of the table. The tuning of sting position is supported by the longitudinal adjustability of the organbath. This solution allows the simultaneous measurement of multiple embryos.

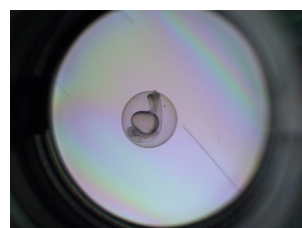
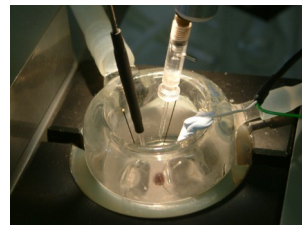

2. Measuring system

The measuring system consists of three main units:

- INT-01 high input impedance ($10^{12}\Omega$), low noise and capacity (25pF) amplifier,
- EXP-ST-A1 stimulating terminal stage with isolator (10V/10mA),
- INTRASYS measuring, analyzing and data storing hardware-software system with stimulator module.

In order to avoid external noise contamination (since the system does not contain any filter) and to keep low capacity with the mechanics we designed a shielding grounding point. Through this point we can connect to the shielding grounding point of the Faraday cage.

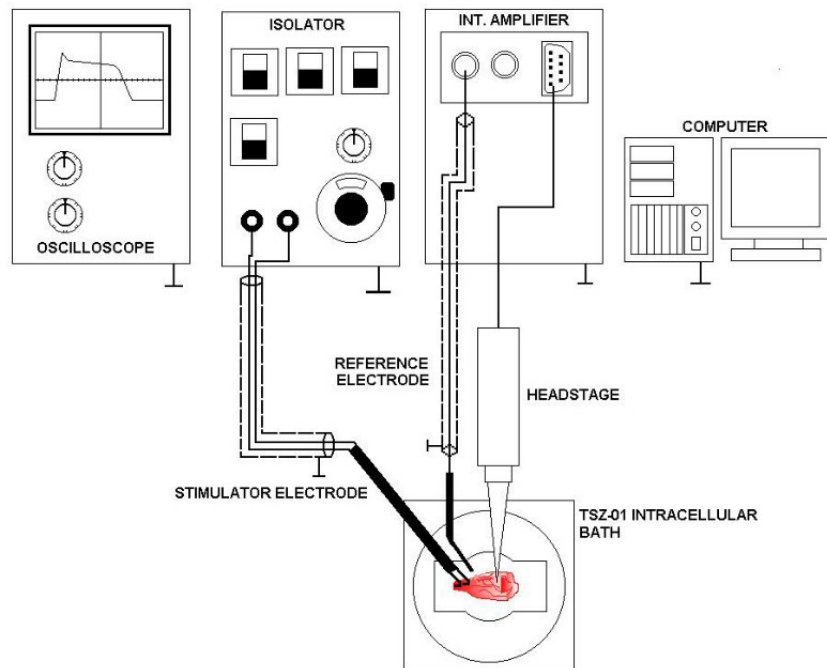

INT-01 amplifier

The INT-01 amplifier was developed to the **standard microelectrode technique**. The applied technical solutions allow us to accurately transfer the shapes of the AP signals while using glass electrodes between $10M\Omega$ and $100M\Omega$. The amplifier consists of two units. One of its elements is the "INTE" high input impedance preamplifier, which can be directly connected to the electrode sleeve (e.g.: WPI, Harvard, Clark, etc.). The other element is the power amplifier, which also contains the previously described circuit elements and provides the connection to the data imaging, -storing and -analyzing hardware-software system.

In order to achieve these favorable parameters, we chose the linear amplifier solution with reference work ground solution. All the services, provided by the amplifier (e.g.: capacity compensation, resistance measurement, DC electrode contact potential cancellation etc.) can be controlled through the constant resistance (1Ω) reference work ground.

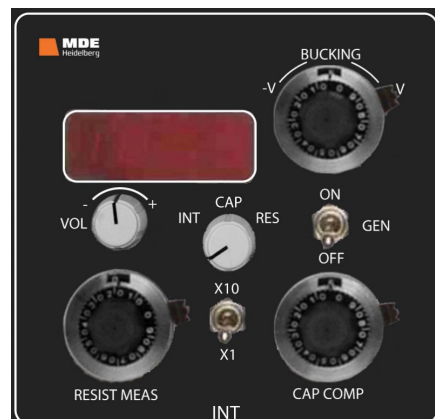

EASY-CEL hardware-software

The EASY-CEL is a one-channel storing oscilloscope software. The software can be used to display, store and analyze extra-, and intracellular potentials, which were triggered in heart or any other anatomical field (e.g.: brain, bone marrow, etc.) *in-vivo* or *in-vitro* way.

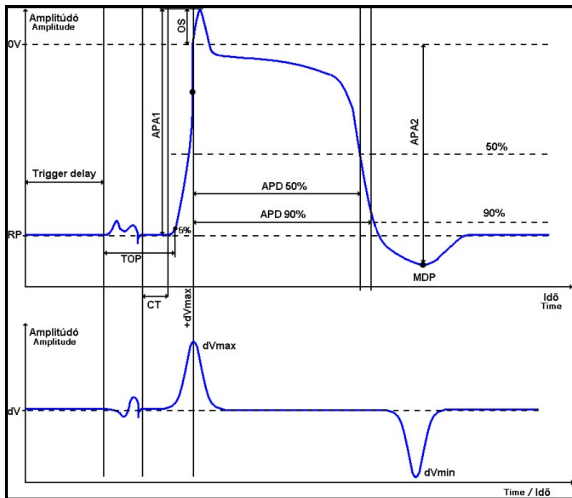

Heart one cell

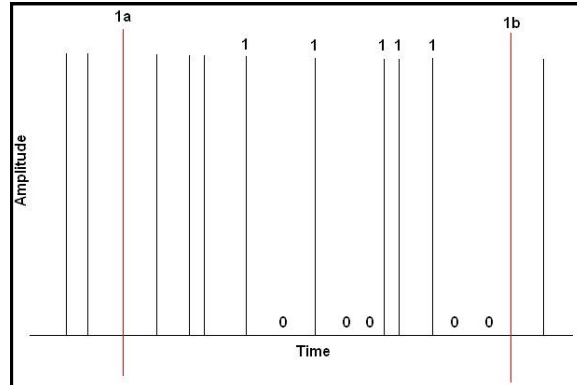

One-cell activity (unit activity)

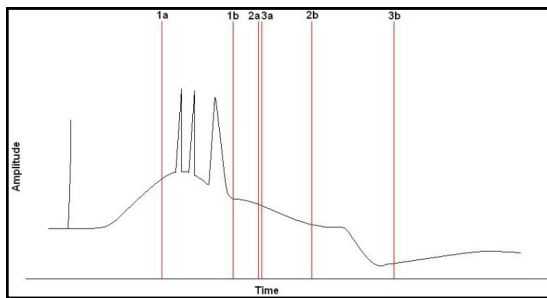

Intracellular one neuronal cell

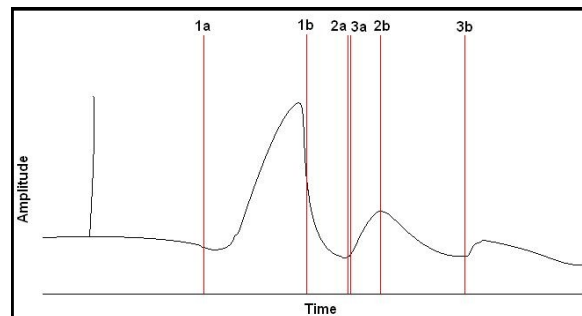

Extracellular neuronal potential

Heart one cell registration

For heart AP curves measured with **standard microelectrode technique**, in online mode the following parameters are displayed, analyzed and stored, during the measurement. Later, in offline mode the primer curves and the saved parameters can be reanalyzed and modified:

- **RP** – rest potential
- **TOP** – taking off potential
- **APA1** – AP to the RP = OS – RP
- **APA2** – AP to the MDP = OS – MDP
- **MDP** – minimum potential
- **OS** – overshoot
- **APD10** –10% coming back
- **APD25** –25% coming back
- **APD50** –50% coming back
- **APD75** –75% coming back
- **APD90** - 90% coming back
- **APD50mV** –50mV coming back
- **CT** – leading time
- **dVmax** – the fastest point of the rising branch of the sign
- **dVmin** – the fastest point of the descending branch of the signal.

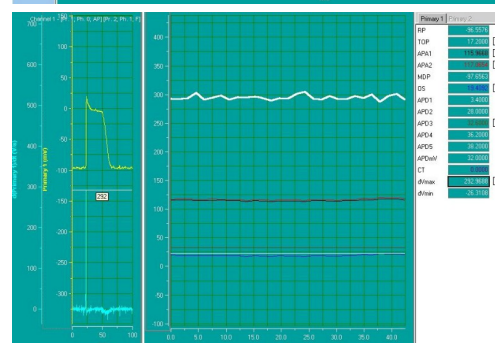
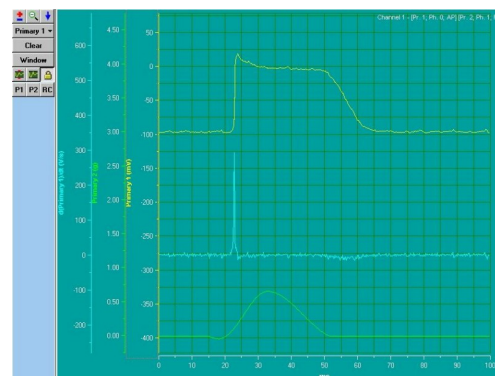

Featured services

Store mode

provides an opportunity to display a primer curve any time during the measurement, which was stored in a specific moment, and to compare this curve with the other curves measured or monitored at that given identical moment. In addition there is a possibility to calculate an average from the curves (averaged).

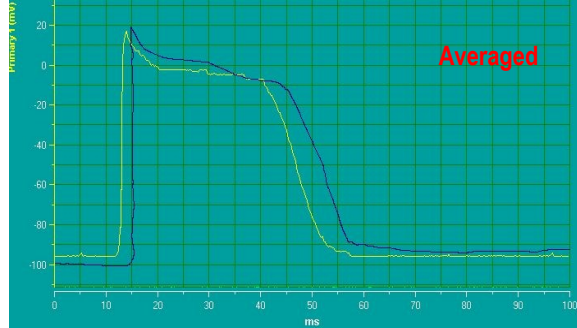
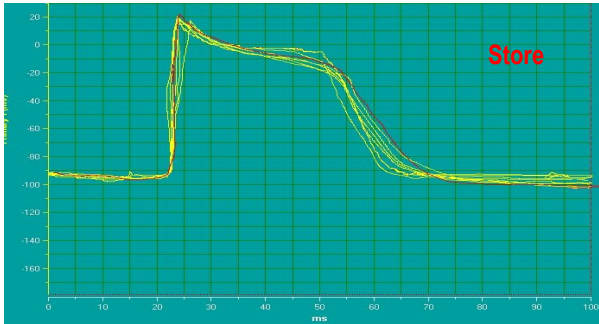

Internal stimulator EXP-ST-A1 isolator with performance stage:

Parameter ranges:

Pulse Period (PP) 500 micro sec ... 999 sec

Delay (DE) 0.1 micro sec ... 999 sec

Impulse Width (PW) 10 micro sec ... 999 sec

Train Delay (TD) 10

Train Number (TN) 1 ... 999

EXP-ST-A1 performance stage:

Max. output voltage ± 10 V, ± 100 V

Current limit ± 10 mA, ± 100 mA

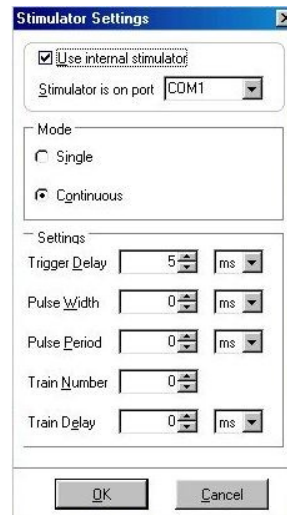

The system can be purchased in two different design

- **Complete Workstation (Workstation)**

which integrates the amplifier (INT-01), the hardware interface, the software, the isolator output stage (EXP-ST-A1) and the computer.



- **Built up from units (according to individual demand)**

Upon request, the system can be set up according to individual needs from the following units:



Additional devices



SEN-12 360° ball manipulator with stimulating electrode



MAN-07 Precision manipulator (1µmm/pace X, Y plane)

SEN-12 360° ball manipulator with stimulating electrode

HOW CAN THE SYSTEM HELP?

The advantage of the STANDARD MICROELECTRODE methodology

The recent decades proved that the zebrafish is a preferred research subject of cardiac research, especially in heart physiological and pharmacological tests. The heart electrophysiology of zebrafish shows similarity in many points to mammals which are used for experimental research (e.g.: ion channels, ECG, etc.), and it has a unique development physiological applicability. Based on the analyzed similarities, the cellular techniques (standard microelectrode, patch clamp) applied for mammals also appeared in zebrafish studies.

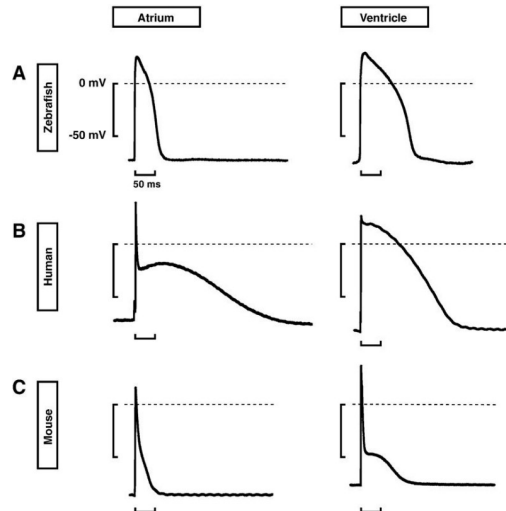

Representative shapes of **atrial** (left column) and **ventricular** (right column) cardiac action potentials in the adult **zebrafish** (A), **human** (B) and **mouse** (C). APs were recorded from spontaneously beating intact zebrafish hearts at 28°C, while human and mouse cardiac tissues were stimulated at a frequency of 1 Hz and measured at 37°C. Zebrafish recordings were obtained from the apical half of the ventricle and from the central area of the atrium.

The advantage of **standard microelectrode** technique is that it registers the transmembrane changes through the amplifier from the dissection stung with the electrode, in such a way that from a cell of the dissection, the tip of the electrode detects electrical potential changes of the intracellular space related to the extracellular space. With this technique it becomes possible to measure the voltage triggered by all the ion channels in the given cell, between the extra-/intracellular space. The sum signal, which is mapped by the measurement method, defines the formation of the heart physiological measurement method, the ECG curves, which are well spread in the clinical practice.

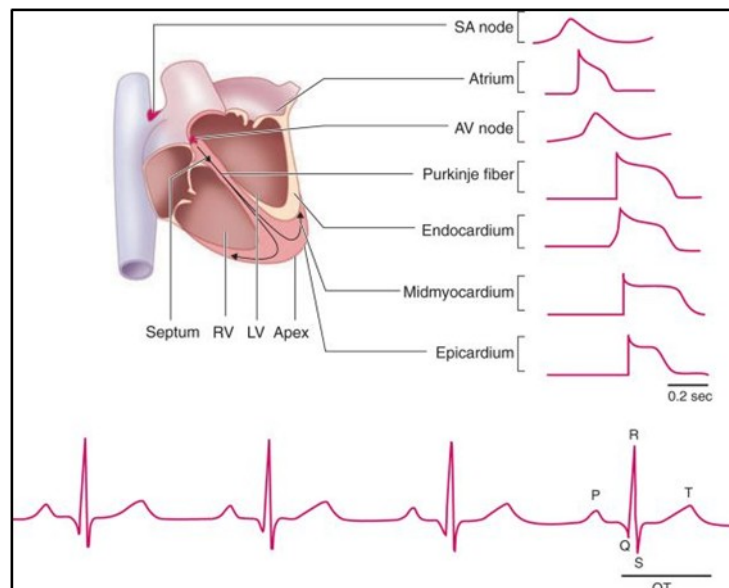

The introduction of the measuring unit

The parameters of the analogue amplifier of the **standard microelectrode** measuring unit described previously, the high input resistance and the low capacity ($10^{12} \Omega/25\text{pF}$) guarantees the form keeping transmission of AP signals in case of 10-90 M Ω electrode resistance. The positive input parameters and the asymmetrical arrangement results in a low leakage current, which is – in contrast to the clamp amplifiers – ensures the proper ramp slope for the AP signal, so the physiological information represented by the DV/DT value will not be distorted.

With the background support of the amplifier (INT-01) we can ensure the AP signal transmission process and measurement go as smooth as possible. In addition to that the user is continuously informed of the technical status of the devices, ensuring an objective monitoring of the status of the biological dissection. These services are organically integrated into the amplifier and can be monitored via the 3 digit LED and audio display:

- Baseline setting (bucking),
- Capacity-compensation,
- Electrode resistance measurement,
- Sound monitor.

Upon the measurement of each physical features we have been striving to not only check the technical parameters of the amplifier, but also the status of the biological dissection to be measured. For this purpose we developed a 1 Ω -os reference (REF) land, which is independent from the electronic and the shielding grounds (GND).

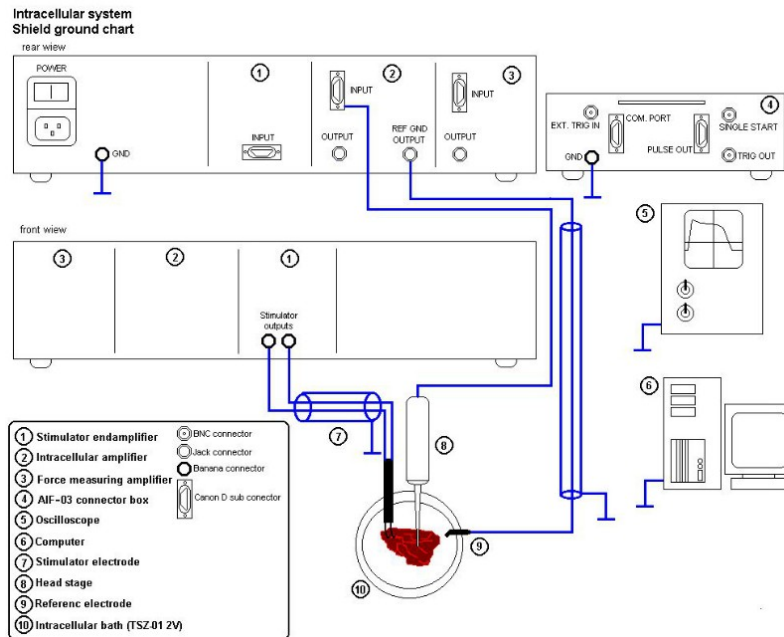

REF and GND ground measuring layout

As a result of the solution the capacity of the system reduces, the fluctuation of the baseline (zero level) can be stabilized and it only depends on the status of the Ag/AgCl reference electrode, which can be checked this way.

Electrode resistance measurement

The resistance is measured by the principle of conductivity measurement, by equalizing two facing, opposite phase square wave. The two opposite phase waves pass through the electrode and the dissection, and after the leveling, the value can be read off the LED display (measurement range= 10-100M Ω).

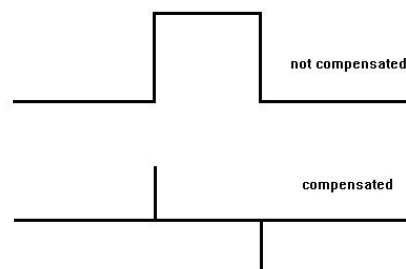

Baseline setting (bucking)

The measurement accuracy is deteriorated if the level of baseline cannot be set correctly. This voltage shift can be caused by two factors:

1. The incorrect setting of amplifier offset voltage, which can be corrected by the offset voltage setting of the circuits in the amplifier.
2. At the contact potential of the electrode and dissection connection point. This problem has two possible solutions:
 - Set a zero level in the amplifier (e.g.: due to the construction of the clamp amplifiers, they use this solution),
 - Deleting the potential directly at the connection point of the electrode and the dissection. It has an advantage that the potential, which is not connected to the measured signal, cannot reduce the useful signal, and will not saturate the input stage. In this way the whole measuring range can be exploited, and the AP curve transmission will not be distorted. This is supported by the $\pm 100\text{mV}$ voltage level, which can be carried through the REF earth, and can be set by the **bucking** potentiometer.

