



# Laboratory glassware washing systems

High Capacity

**Miele**

Group  
Member

ANIMA  LAB

# Customization. Innovation. Excellence.

## Driven by customer needs

Steelco is a leading infection control solution provider, supplying the healthcare, laboratory research and pharma sectors. Active in over 100 countries, Steelco has equipped numerous world renowned hospitals and counts among its customers household names in the laboratory, pharmaceutical and industrial sectors.

Driven by customer feedback, Steelco develops, manufactures and supplies solutions that maximize infection control, safety, optimize processes and minimize costs. Already a leader in innovation in areas such as automation, the integration within the Miele organization has provided additional boost in technological development.

Steelco provides technical service and user training courses at the Steelco Academy as well as at customer sites. Our optional remote diagnostics capabilities and worldwide team of factory trained engineers ensure that you receive the service support you need to cost effectively maximize the uptime of your equipment.



**Miele** Group  
Member

# Medium and Large Size Laboratories

Steelco's understanding of the requirements of modern biomedical research and laboratory facilities results in a wide selection of individually tailored solutions to meet the diverse needs of the Life Sciences industry.

Our laboratory washers and sterilizers are leaders in safety and contamination prevention, focusing on cleanliness, reliability, and consistency. Their versatility and automation guarantee workflow optimization at minimal costs.

Our range of high-capacity laboratory glassware washers and dryers provides fast, reliable, and efficient washing and drying results. Multiple chamber configurations, state-of-the-art technologies and machine integrations ensure excellent performance and workflow optimization.



**LAB 640**  
350 lt / 12.4 ft<sup>3</sup>

**LAB 1000**  
500 lt / 17.7 ft<sup>3</sup>

**LAB 660/680**  
600 lt / 21.2 ft<sup>3</sup>

**LAB 1500**  
568 lt / 20 ft<sup>3</sup>

# Key Advantages

## a winning combination

Our complete range of glassware washers and dryers, carefully designed to effectively treat daily use materials in scientific laboratories, provides optimum cleaning, HEPA 14 drying efficiency, and maximum safety, ensuring unrivaled levels of efficiency.

Tailor-made customization, combined with a wide selection of trolleys and accessories, meets the most diverse treatment needs.



### Optimized Process Speed

Quality and speed of the washing process are of utmost importance as well as water, detergent and energy consumption. Our washing systems can be configured with preheating tanks with water and energy recovery systems and ensure a high flow rate combined with adequate spray pressure.



### Process Quality Focus

High-quality stainless steel AISI 316 washing chamber and washing arms for optimal performance, with washing and drying injection system integrated into the same circuit. Low friction bearings ease chamber and cart washing arms rotation for improved efficiency in water and air distribution.



### Loading Configuration Flexibility

A comprehensive choice of racks and accessories to meet different capacity and cleaning demands, allowing to maximize the numbers of different utensils and glassware that can be washed, preventing movement and damage, and ensuring complete coverage of the loads.



### Washing Carts Customizable

The final pages of the catalog are dedicated to choosing the most appropriate optimal accessories for convenient loading and to the selection of injection nozzles to set up configurable wash carts.

.....

Steelco Laboratory glassware washers comply with the current European directives and standards as follow: 2006/42/EC, 2014/35/EU, 2014/30/EU and 2011/65/EU Directives, EN 61010-1, EN 61010-2-040, EN 61326-1, EN ISO 15883-1 current standards.

# LAB 640 SL

## Freestanding Glassware Washer



Injection washing and drying on 4 independent levels with 3 possible rack locations

### Overall Dimensions WxDxH:

765 x 800 x 1975 mm  
30 1/8" x 31 1/2" x 77 3/4"

### Chamber Volume

~350 lt / 12.36 cu ft

### Basket Volume

~280 lt / 9.89 cu ft

The LAB 640 SL is a large capacity, fully automatic frontal loading laboratory glassware washer aimed to satisfy medium/large size facility needs.

Available in electrical or steam heated versions, this washer is equipped with a motorized vertical sliding down door thus allowing the reduction of the space needed in the laboratory.

A pre-heating tank configured with electrical heating elements allows for a no-recirculate final rinse.

### Key Features:

- + Single-pass final rinse option
- + Flow meter and conductivity sensor for quality process.
- + Triple water filtering system
- + Drying efficacy, powerful built-in HEPA filtered forced hot air drying system, with adjustable time and temperature.
- + Easy access to chemicals.
- + 5.7" user-friendly HMI, touch screen display, 65 programs.
- + USB port for the monitoring data download. On board integrated thermal printer for validating washing phases as an option.

## Washing carts configurations LAB 640 L

### Level positions

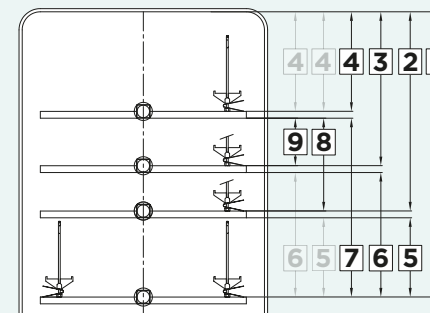

1	630 mm / 24 13/16"
2	440 mm / 17 5/16"
3	340 mm / 13 3/8"
4	220 mm / 8 11/16"
5	170 mm / 6 11/16"
6	270 mm / 10 5/8"
7	390 mm / 15 3/8"
8	200 mm / 7 7/8"
9	100 mm / 3 15/16"

The use of an upper level washing cart provided with spray arm reduces the useful height of the level placed below by 40mm/1 9/16" but allows a gain of 15mm/9/16" on top.

### Upper and lower level empty racks

The table shows the maximum glassware diameter in the washing cart frame and position options.

empty rack code	max Ø mm/in.	nr. of injection positions	Upper level	Lower level	notes
C1412E	41 / 1 5/8	208	①	U/L	only for mm 2,5/0.1" Ø nozzles
C1411E	51 / 2	137	①	U/L	only for mm 2,5/0.1" Ø nozzles
C1408E	60 / 2 3/8	90	①	U/L	only for mm 2,5/0.1" Ø nozzles
C1407E	76 / 3	56	①	U/L	only for mm 2,5-4/0.1-0.16" Ø nozzles
C1521E	80 / 3 1/8	36	①	U/L	
C1406E	95 / 3 3/4	35	①	U/L	
C1518E	110 / 4 5/16	22	①	U/L	
C1405E	120 / 4 3/4	18	①	U/L	
C1519E	135 / 5 5/16	14	①	U/L	
C1520E*	180 / 7 1/16	8	①	U/L	
C1410E	95 / 3 3/4	20	⑤	U	

\* Inserts for glassware alignment/support for C1520:  
C1520900 max Ø 180mm / 7 1/16"  
C1520901 max Ø 100mm / 3 15/16"



Right below you can find examples of configured washing carts and reference of the maximum glassware diameter and number of injection positions.

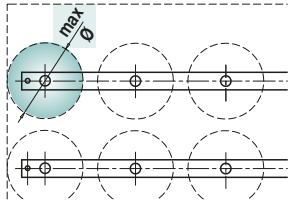

**Glassware diameter**

Top view of a portion of an injection washing cart showing the maximum glassware diameter.

**Wash cart frame selection for custom configurations**

Selection of an empty rack enables users to customize the wash cart frame using different nozzles and accessories. See final pages of the catalogue.

**Full loading space**

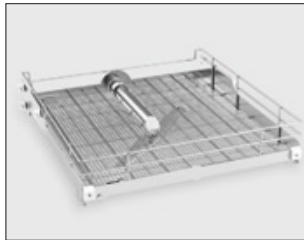

**C1390** Upper washing cart with washing arm, loading space 570x600mm (22 7/16" x 23 5/8")

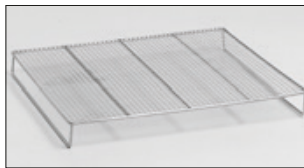

**C1502** Support grid to have a flat surface on a C1390, usable height reduced by 50mm/2"



**C1389** Lower washing cart, loading space 570x600mm (22 7/16" x 23 5/8")

**Injection nozzles for small size glassware**



**Upper/lower levels**  
Suggested configurations

**A 208 positions**  
max glassware:  
Ø 41mm/1 5/8"  
h 160mm/6 5/16"

**C1412E frame**  
+ 208 nozzles C054544

**B 137 positions**  
max glassware:  
Ø 51mm/2"  
h 180mm/7 1/16"

**C1411E frame**  
+ 137 nozzles C054548

**C 90 positions,**  
max glassware:  
Ø 60mm/2 3/8"  
h 230mm/9 1/16"

**C1408E frame**  
+ 90 nozzles C054549

**Injection nozzles for mid size glassware**



**Upper/lower levels**  
Suggested configurations

**A 56 positions**  
max glassware:  
Ø 76mm/3"  
h 230mm/9 1/16"

**C1407E frame**  
+ 56 nozzles C054549

**B 35 positions**  
max glassware:  
Ø 95mm/3 3/4"  
h 280mm/11"

**C1406E frame**  
+ 35 nozzles C054551

**C 18 positions**  
max glassware:  
Ø 120mm/4 3/4"  
h 330mm/13"

**C1405E frame**  
+ 18 nozzles C054552

**Injection nozzles for large size glassware**



**Upper/lower levels**  
Suggested configurations

**C1404**  
Capacity: up to 8 items  
Ø max 200mm/7 7/8"

**C1403**  
Capacity: up to 5 items  
Ø max 240mm/9 7/16"

**C1515**  
Capacity: up to 4 items  
Ø max 280mm/11"  
7 measuring cylinders:  
4 x max Ø130mm/5 7/8",  
3 x max Ø 180mm/ 7 1/16"

**C1455**  
Capacity: up to 4 items  
Ø max 280mm/11"  
1 measuring cylinder  
Ø max 95mm/3 3/4"

**C1402**  
Capacity: up to 3 items  
Ø max 305mm/12"

**C1670**  
Upper/lower-level washing cart for 2lt graduated cylinders, max 12 pcs

**Injection washing for pipettes**



**C1409** lower level, max **200 positions**.  
Min. pipette length 150mm/5 15/16"  
Max. pipette length 620mm/24 7/16"

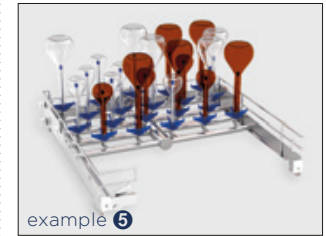

**C1410E** upper level, to be used combined with C1409 wash cart for pipettes

Suggested configuration

**A 20 positions**  
max glassware:  
Ø 95mm/3 3/4"  
h 280mm/11"

**C1410E frame**  
+ 20 nozzles C054551

# LAB 1000

## High Capacity Pass-Through Double Door Glassware Washer



Injection washing and drying on up to 4 independent levels with 3 possible rack locations

### Overall Dimensions WxDxH:

1100 x 960 x 1940 mm  
43 <sup>5</sup>/<sub>16</sub>" x 37 <sup>13</sup>/<sub>16</sub>" x 76 <sup>3</sup>/<sub>8</sub>"

### Chamber Volume

~500 lt / 17.66 cu ft

### Basket Volume

~350 lt / 12.36 cu ft

LAB 1000 is a large capacity glassware washer specially developed for laboratories that require to clean large quantities of items on a daily basis.

Steelco LAB 1000 ensures outstanding washing and drying results of all laboratory glassware thanks to the accurate distribution of the air on all the chamber zones and on the washing cart levels.

A built-in pre-heating tank is available upon request to perform faster washing cycles. In this configuration the washer can perform a complete cycle in less than 40 minutes.



LAB 1000 washing cart system comprises a support washing cart that can be configured with removable cassettes on two levels.

### Key Features:

- + Electrical or steam heated.
- + Single or double door pass through version.
- + Two standard peristaltic pumps. Additional dosing pump available as option.
- + Flow meter and conductivity sensor.
- + Powerful built-in HEPA filtered forced hot air drying system with adjustable time and temperature.
- + Triple water filtering system.
- + Easy access to chemicals.
- + 5.7" user-friendly HMI, touch screen display, 65 programs.
- + USB port for the monitoring data download. On board integrated thermal printer for validating washing phases as an option.
- + Loading and unloading washing carts by using manual or automatic transfer trolleys.

## Washing carts configurations LAB 1000

### Level positions

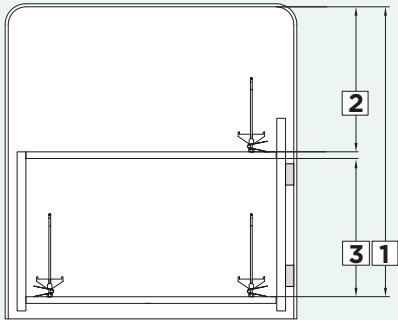

1	605 mm / 23 13/16"
2	275 mm / 10 13/16"
3	315 mm / 12 3/8"

The use of an upper level washing cart provided with spray arm reduces the useful height of the level placed below by 40mm/1 9/16" but allows a gain of 15mm/9/16" on top.

### Upper and lower level empty racks

The table shows the maximum glassware diameter in the washing cart frame and position options.

empty rack code	max Ø mm/in.	nr. of injection positions	Upper level Lower level
C409E	40 / 1 9/16"	99	① all
Notes: only mm 2,5/0.1" Ø nozzles can be used			
C407E	50 / 2	76	① all
C402E	75 / 2 15/16"	34	① all
C406E	98 / 3 7/8"	24	① all
C403E	92 / 3 5/8"	22	① all
C470E	104 / 4 1/16"	18	① all
C469E	190 / 7 1/2"	5	① all

Right below you can find examples of configured washing carts and reference of the maximum glassware diameter and number of injection positions.

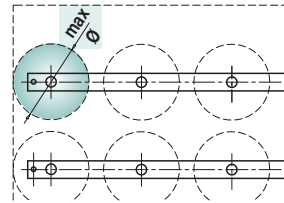

### Glassware diameter

Top view of a portion of an injection washing cart showing the maximum glassware diameter.

### Base injection washing cart



### C400W

Base injection washing cart suitable for removable cassettes on 2 levels

### Injection Washing for Pipettes



### C408

lower vertical pipettes cassette 68 positions.  
Minimum pipette length 270mm/10 5/8"  
Maximum pipette length 590mm/23 1/4"

### Injection nozzles all levels

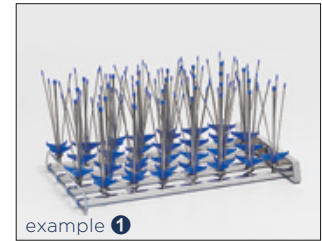

example ①

Suggested configurations

**A 34 positions**  
max glassware:  
Ø 75mm/2 15/16"  
h 160mm/6 5/16"

composition:  
**C402E frame**  
+ 34 nozzles C054548



example ①

**B 24 positions**  
max glassware:  
Ø 98mm/3 7/8"  
h 230mm/9 1/16"

composition:  
**C406E frame**  
+ 24 nozzles C054550

### Wash cart frame selection for custom configurations

Selection of an empty rack enables users to customize the wash cart frame using different nozzles and accessories. See final pages of the catalogue.

# LAB 660 - LAB 680 Series

High Capacity Swing Door Glassware Washers



## LAB 660 Series



Injection washing and drying on 3 independent levels with 3 possible rack locations.

### Overall Dimensions WxDxH:

1140 x 930 x 1685 mm  
44 7/8" x 35 5/8" x 77 3/4"

### Chamber Volume

~600 lt / 21.19 cu ft

### Basket Volume

~430 lt / 15.18 cu ft

## LAB 680 Series



Injection washing and drying on 5 independent levels with 4 possible rack locations

**Two washing pumps** feeding washing circuits.

The LAB 660 and LAB 680 are high capacity frontal loading glassware washers designed to meet the needs of medium and large facilities, with the capacity of cleaning bottles for up to 100 lt / 22 Gal US.

Electrical or steam heated, the two washers are capable of injection washing on multiple levels providing maximum flexibility through multiple chamber configurations depending on the height of the loaded items. The drop down hinged door with glass window serves as a loading platform at convenient height for the bottom level.

### Key Features:

- + **Electrical or steam heated**
- + **Chemical dosing**  
Two standard peristaltic pumps. Additional dosing pump available as option.
- + **Drying efficacy**  
Powerful built-in HEPA filtered forced hot air drying system. Adjustable time and temperature settings for the optimization of cycle duration and energy consumption.
- + **Easy access to chemicals**  
Frontal sliding drawer for storage of chemicals, up to three tanks of 10 lt / 2.64 Gal US.
- + **User friendly HMI**  
High safety and easy to use LCD display control system, 40 programs.
- + **Traceability**  
RS 232 dedicated port for printer or PC connection to monitor and validate washing/disinfection cycles.





## Washing Efficacy

Washing pumps feeding washing circuits to ensure high flow rate combined with effective spray pressure. The washing chamber and spray arms, as well as tank filters, are made of high quality AISI 316 L stainless steel (DIN 1.4404).



## Smart Filtering System

Design quality and proper maintenance are critical to ensure compliance with standards, sustainability, and an enduring life cycle. Our Lab Series of glassware washers is equipped with a triple water filtering system. Ergonomically accessible from the washing chamber, it captures residues preventing their recirculation, thus extending pump life.



## Easy and safe loading/unloading

Ergonomic design of the door level height allows a convenient loading/unloading job to the user, with the additional support of a manual loading/unloading trolley upon request.

Telescopic bearing rails enable easy and safe loading/unloading of the glassware. The upper levels can be removed depending on the height of the loaded glassware.



## Easy maintenance and access to chemicals

The machine is developed considering technicians' access to the maintenance and service area - easy access to all components and electrical cabinet. Frontal sliding drawer for storage of chemical containers, up to three tanks of 10 lt / 2.64 Gal US.



## Washing carts configurations LAB 660-680

### LAB 660 level positions

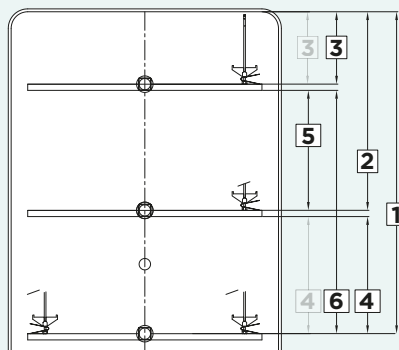

1	770 mm / 30 5/16"
2	480 mm / 18 7/8"
3	170 mm / 6 11/16"
4	280 mm / 11"
5	290 mm / 11 7/16"
6	580 mm / 22 13/16"

### LAB 680 level positions

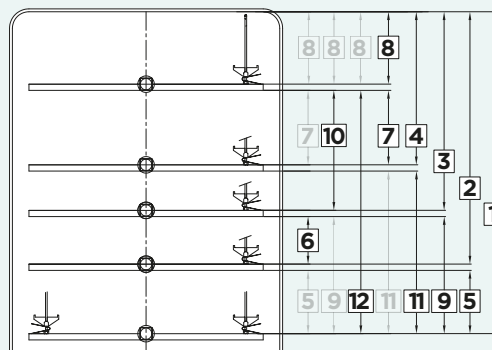

1	770 mm / 30 5/16"
2	610 mm / 24"
3	480 mm / 18 7/8"
4	370 mm / 14 9/16"
5	150 mm / 5 15/16"
6	115 mm / 4 1/2"
7	180 mm / 7 1/16"
8	170 mm / 6 11/16"
9	280 mm / 11"
10	290 mm / 11 7/16"
11	390 mm / 15 3/8"
12	580 mm / 22 13/16"

The use of an upper level washing cart provided with spray arm reduces the useful height of the level placed below by 50mm/2" but allows a gain of 15mm/9/16" on top.

### LAB 660 - LAB 680 Upper and lower level empty racks

The table shows the maximum glassware diameter in the washing cart frame and position options.

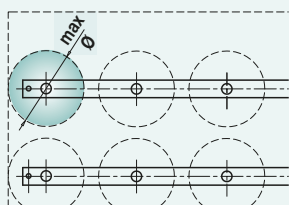

#### Glassware diameter

Top view of a portion of an injection washing cart showing the maximum glassware diameter.

empty rack code	max Ø mm/in.	nr. of injection positions	Upper level	Lower level	notes
C423E	25 / 1	330	1	U	only for mm 2,5/1/8" Ø nozzles
C410E	65 / 2 9/16	72	1	U	
C411E	84 / 3 5/16	56	1	U	
C425E	90 / 3 9/16	48	1	U	
C1238E	105 / 4 1/8	35	1	U	
C444E	150 / 5 15/16	18	1	U	
C413E	85 / 3 3/8	21	2	U	mm 480x585 / 18 7/8"x23" space
C421E	75 / 2 15/16	40+121	3	U	see C1086, C1061, C1105 accessories
C414E	75 / 2 15/16	72	1	L	
C415E	85 / 3 3/8	56	1	L	
C424E	90 / 3 9/16	48	1	L	
C1239E	105 / 4 1/8	35	1	L	
C443E	150 / 5 15/16	18	1	L	
C426E	190 / 7 1/2	10	1	L	
C427E	250 / 9 13/16	6	1	L	

Right below you can find examples of configured washing carts and reference of the maximum glassware diameter and number of injection positions.

### Wash cart frame selection for custom configurations

Selection of an empty rack enables users to customize the wash cart frame using different nozzles and accessories. See final pages of the catalogue.

**Full loading space**



**C420** Upper washing cart with washing arm, loading space 585x765mm (23"x30 1/8")

**C419** Lower washing cart without washing arm, loading space 620x765mm (24 7/16"x30 1/8")

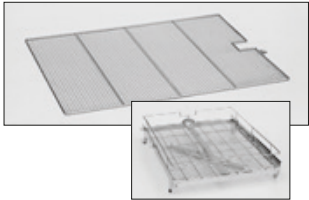

**C446** Grid to allow the loading of small object on std. washing carts dim. 752x582mm (29 5/8" x 22 15/16")

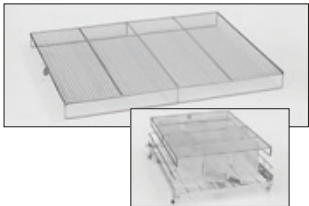

**C447** Grid cover to be positioned over light object dim. 752x582mm (29 5/8"x22 15/16")

**Injection nozzles for small size glassware**

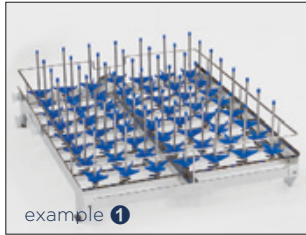

**Upper levels**  
Suggested configurations

**A 72 positions**  
max glassware:  
ø 65mm/2 9/16"  
h 160mm/6 5/16"

**C410E frame**  
+ 72 nozzles C054548

**B 48 positions**  
max glassware:  
ø 90mm/3 9/16"  
h 230mm/9 1/16"

**C425E frame**  
+ 48 nozzles C054550

**C 72 positions,**  
mixed nozzles,  
max glassware:  
ø 65mm/2 9/16"  
h 200/300mm

**C410E frame**  
+ 18 nozzles C054550  
+ 54 nozzles C054548

**Injection nozzles for mid size glassware**

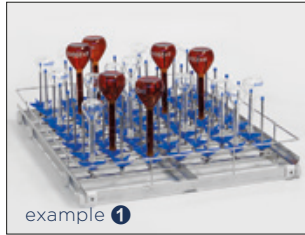

**Lower levels**  
Suggested configurations

**A 72 positions**  
max glassware:  
ø 75mm/2 15/16"  
h 230mm/9 1/16"

**C414E frame**  
+ 72 nozzles C054549

**B 48 positions**  
max glassware:  
ø 90mm/3 9/16"  
h 300mm

**C424E frame**  
+ 48 nozzles C054551

**C 72 positions**  
mixed nozzles  
average glassware:  
ø 75mm/2 15/16"  
h 200/300mm

**C414E frame**  
+ 18 nozzles C054550  
+ 54 nozzles C054548

**D 72 positions**  
mixed nozzles  
with supports,  
max glassware:  
ø 75mm/2 15/16"  
h 180/280mm

**C414E frame**  
+ 18 nozzles C054560  
+ 54 nozzles C054947

**With half space + injection nozzles for mid size**

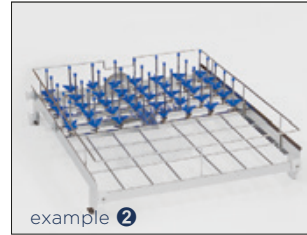

**Upper levels**  
Suggested configurations

**A 21 positions**  
max glassware:  
ø 85mm/3 3/8"  
h 300mm/11 13/16"

**loading space mm**  
480x585 (18 7/8"x23")

**C413E frame**  
+ 21 nozzles C054551

**With injection nozzles for large size glassware**



**C1360** Lower level,  
capacity: up to 4 items  
ø max 240mm/9 7/16",  
1 item ø max 315mm/12 3/8"

**C1177** Lower level,  
capacity: up to 4 items  
ø max 300mm/11 13/16"

**C1178** Lower level,  
capacity: up to 2 items  
ø max 400mm/15 3/4"

**With injection nozzles + nozzles for vials**

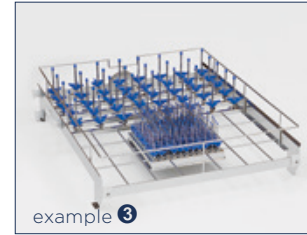

**Upper levels**  
Suggested configurations

**A 121 positions**  
max glassware  
ø 20mm/13/16"  
h 160mm/6 5/16"

**40 positions**  
max glassware:  
ø 75mm/2 15/16"  
h 230mm/9 1/16"

**C421E frame**  
+ 121 nozzles C054544  
+ 40 nozzles C054549

note: see also C1061,  
C1086 and C1105  
accessories

**Injection washing for pipettes**



**C416** lower level  
**max 88 positions.**  
Min. pipette length  
300mm/11 13/16"  
Max. pipette length  
450mm/17 3/4"  
with 2 upper levels installed  
and 700mm/27 9/16" with  
1 upper level installed.

**Immersion washing for pipettes**

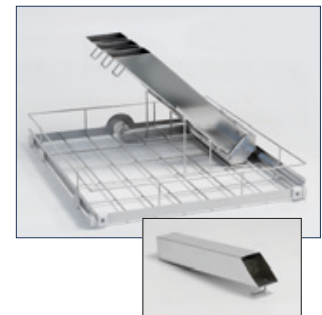

**C418** Lower level  
with 3 pipettes cassettes,  
Max. pipette length  
520mm/20 1/2"

**C417** Lower level  
with 2 pipettes cassettes,  
Max. length 520mm/20 1/2"

Pipettes must be fully  
covered by water and  
therefore must stay within  
the cassette.



# LAB 1500

## High Capacity Laboratory Glassware Washer and Dryer



The LAB 1500 is a high capacity glassware washer and dryer specially developed for laboratories that require to clean large quantities of items on a daily basis.

This lab washer features a full visibility motorized space-saving sliding down door.

Two heavy duty washing pumps dedicated to separate washing – providing a high water flow rate combined with adequate spray pressure – ensure outstanding glassware washing results.

As standard, two peristaltic pumps provide precise dosing of liquid chemical agents. A convenient hinged door allows for easy access to storage of up to two 10-liter / 2.64 Gal US chemical tanks.



Injection on up to 6 levels with 8 possible rack locations

### Overall Dimensions WxDxH:

1350 x 840 x 1985 mm

53" x 33" x 78"

### Chamber Volume

568 lt / 20 cu ft

### Basket Volume

~ 369 lt / 13 cu ft

### Key Features:

#### + Flexible solutions

The electrical or steam stainless steel heat exchanger provides rapid heating of water in washer sump.

#### + Drying efficacy

Built-in HEPA 14 filtered forced air drying with adjustable temperature and time settings.

#### + Easy loading/unloading

with fully extendable telescopic rails.

#### + Tank for no-recirculated final rinse

A pre-heating tank configured with electrical heating elements allows for a no-recirculate final rinse.

#### + Process quality

Flow meters for redundancy chemical dosing control and a conductivity sensor.

#### + 7" user-friendly HMI

Industrial PLC with intuitive 7" touch-screen HMI, allowing for 65 programming options.





## High and Flexible Capacity

With a chamber volume of ~ 484 lt / 19.95 cu ft, the LAB 1500 has the largest chamber capacity in the market within the smallest footprint. The device is capable of injection washing on up to 6 levels with 8 possible rack locations, providing maximum flexibility through multiple chamber configurations.



## Washing Efficacy

High-quality AISI 316 L washing chamber and four rotatory spray arms, two on the bottom and two on the top of the chamber, ensure optimal washing performance. Additional spray arms are available on dedicated upper level wash carts.



## Aquatic Tank Package

Specific kit designed for the reprocessing of the aquatic tank used in vivarium and research facilities. It includes three chemical dosage pumps, an upgrade to washing circuit, flow meters, and conductivity probe.



## Complete Traceability

SteelcoData View software is designed to monitor, collect and record data and cycles parameters (time, temperature, cycle consumption, historical alarm data) from up to 15 Steelco devices to one computer. Information collected in real-time is traced and efficiently visualized for device monitoring and data management.



## Washing carts configurations LAB 1500

### Level positions

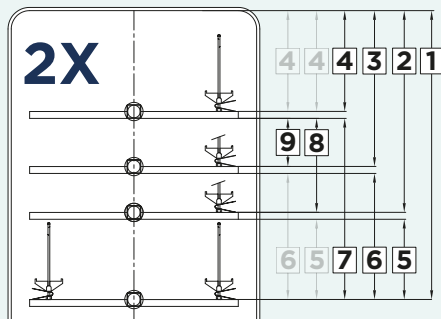

1	630 mm / 24 13/16"
2	440 mm / 17 5/16"
3	340 mm / 13 3/8"
4	220 mm / 8 11/16"
5	170 mm / 6 11/16"
6	270 mm / 10 5/8"
7	390 mm / 15 3/8"
8	200 mm / 7 7/8"
9	100 mm / 3 15/16"

The use of an upper level washing cart provided with spray arm reduces the useful height of the level placed below by 40mm/1 9/16" but allows a gain of 15mm/9/16" on top.

empty rack code	max Ø mm/in.	nr. of injection positions	Upper or Lower level	notes
C1092E	32 / 1 1/4	156	1 U	only for mm 2,5/1/8" Ø nozzles
C1192E	40 / 1 9/16	110	1 U	only for mm 2,5/1/8" Ø nozzles
C837E	35 / 1 3/8	84	1 U	only for mm 2,5/1/8" Ø nozzles
C724E	70 / 2 3/4	42	1 U	
C1603E	80 / 3 1/8	36	1 U	
C725E	100 / 3 15/16	20	1 U	
C838E	110 / 4 5/16	16	1 U	
C1443E	75 / 2 15/16	27	1 U	
C746E	75 / 2 15/16	24+121	3 U	see C1086, C1061, C1105 accessories
C1148E	25 / 1	121	4 U	only for mm 2,5/1/8" Ø nozzles
C1093E	40 / 1 9/16	110	1 L	only for mm 2,5/1/8" Ø nozzles
C1860E	52 / 2 1/16	70	1 L	only for mm 2,5-4/1/8-3/16" Ø nozzles
C1861E	60 / 2 3/8	56	1 L	only for mm 2,5-4/1/8-3/16" Ø nozzles
C729E	70 / 2 3/4	42	1 L	
C1604E	80 / 3 1/8	36	1 L	
C730E	100 / 3 15/16	20	1 L	
C839E	110 / 4 5/16	16	1 L	
C1442E	75 / 2 15/16	27	1 L	
C1862E	130 / 5 1/8	12	1 L	
C1863E	160 / 6 5/16	9	1 L	
C1864E	70 / 2 3/4	24	2 L	mm 230x490 / 9 1/16"x19 5/16" space
C1865E	100 / 3 15/16	12	2 L	mm 220x490 / 8 11/16"x19 5/16" space
C836E	75 / 2 15/16	24+121	3 L	see C1086, C1061, C1105 accessories
C1149E	25 / 1	121	4 L	only for mm 2,5/1/8" Ø nozzles

The table shows the maximum glassware diameter in the washing cart frame and position options.

### Full loading space



**C728** Upper washing cart with washing arm, loading space 485x525mm (19 1/16"x 20 11/16")

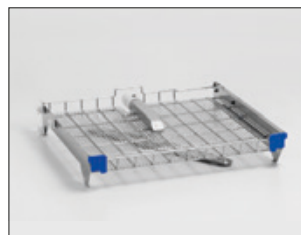

**C1512** Upper level wash cart with washing arms



**C1853** Upper/lower wash cart without washing arms, loading space 470x540mm (18 1/2"x21 1/4")

### With injection nozzles for mid size glassware



example 1

**Upper level**  
Suggested configurations

**A 42 positions**  
max glassware:  
Ø 70mm/2 3/4"  
h 160mm/6 5/16"

**C724E frame**  
+ 42 nozzles C054548

**B 20 positions**  
max glassware:  
Ø 100mm/3 15/16"  
h 230mm/9 1/16"

**C725E frame**  
+ 20 nozzles C054550

**C 42 positions**  
mixed nozzles  
average glassware:  
Ø 70mm/2 3/4"  
h 200/300mm

**C724E frame**  
+ 10 nozzles C054550  
+ 32 nozzles C054548

### With injection nozzles for mid size glassware

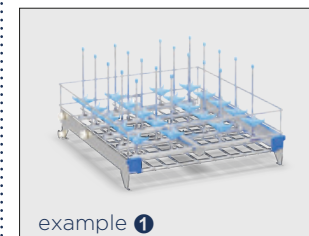

example 1

**Lower level**  
Suggested configurations

**A 42 positions**  
max glassware:  
Ø 70mm/2 3/4"  
h 230mm/9 1/16"

**C729E frame**  
+ 42 nozzles C054549

**B 20 positions**  
max glassware:  
Ø 100mm/3 5/16"  
h 300mm/11 13/16"

**C730E frame**  
+ 20 nozzles C054551

**C 42 positions**  
mixed nozzles  
average glassware:  
Ø 70mm/2 3/4"  
h 200/300mm

**C729E frame**  
+ 10 nozzles C054550  
+ 32 nozzles C054548

**D 42 positions**  
mixed nozzles  
with supports,  
average glassware:  
Ø 70mm/2 3/4"  
h 180/280mm

**C729E frame**  
+ 12 nozzles C054560  
+ 30 nozzles C054947

**With half space + injection nozzles for glassware**



**Lower level**  
Suggested configurations

**A 24 positions**  
mixed nozzles,  
max glassware:  
Ø 70mm/2 3/4"  
h 200/300mm

loading space 30x490mm  
(9 1/16"x19 5/16")

**C1864E frame**  
+ 12 nozzles C054551  
+ 12 nozzles C054549

**B 12 positions**  
mixed nozzles  
with supports,  
max glassware:  
Ø 100mm/3 15/16"  
h 180/280mm

loading space 220x490mm  
(8 11/16"x19 9 5/16")

**C1865E frame**  
+ 6 nozzles C054560  
+ 6 nozzles C054947

**With injection nozzles for large size glassware**



**Lower level**  
**C1854** up to 4 items Ø  
max 240mm/9 7/16", up to  
5 items Ø max 190mm/9 1/2"  
**C1855** up to 2 items Ø max  
280mm/11"



**C1856** for 50 lt carboy,  
Ø max 400mm/15 3/4"



**C1857** up to 16 positions  
for graduated cylinders:  
max Ø 85mm/3 1/3"  
max height 550mm/21 2/3",

**With injection nozzles for vials**



**Upper level**  
suggested configurations

**A 121 positions**  
max glassware:  
Ø 25mm/1"  
h 90mm/3 9/16"

**C1148E frame**  
+ 121 nozzles C054953  
note: see also C1150  
accessory

**Lower level**  
suggested configurations

**B 121 positions**  
max glassware:  
Ø 25mm/1"  
h 140mm/5 1/2"

**C1149E frame**  
+ 121 nozzles C054953  
note: see also C1150  
accessory

**With injection nozzles + nozzles for vials**

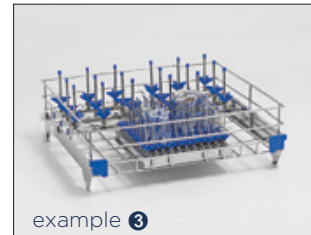

**Upper level**  
suggested configurations

**A 121 positions**  
max glassware:  
Ø 20mm/13/16"  
h 160mm/6 5/16"

**24 positions**  
max glassware  
Ø 75mm/2 5/16"  
h 160mm/6 5/16"

**C746E frame**  
+ 121 nozzles C054544  
+ 24 nozzles C054548  
note: see also C1061, C1086  
and C1105 accessories

**Lower level**  
suggested configurations

**121 positions**  
max glassware:  
Ø 20mm/13/16"  
h 160mm/6 5/16"

**24 positions**  
max glassware  
Ø 75mm/2 5/16"  
h 300mm/11 13/16"

**C836E frame**  
+ 121 nozzles C054544  
+ 24 nozzles C054551  
note: see also C1061, C1086  
and C1105 accessories

**Injection washing for pipettes**



**C1858** lower level,  
**max 56 positions**

Min. pipette length:  
250mm/9 13/16" and  
300mm/11 13/16"

Max. pipette length:  
760mm/29 15/16"

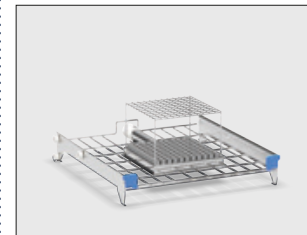

**C1859** lower level,  
**max 121 positions**

Min. pipette length:  
135mm/5 5/16"

Max. pipette length:  
620mm/24 7/16"

**Immersion washing for pipettes**

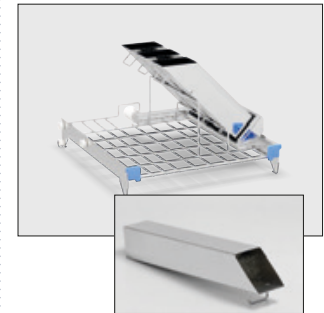

**C1903** lower level, with 2  
pipettes cassettes,  
max. pipette length  
520mm / 20 1/2"

**C1904** lower level, with 3  
pipettes cassettes,  
max. pipette length  
290mm / 11 7/16"

Pipettes must be fully  
covered by water and  
fully immersed within the  
cassette.

## Technical Data

	LAB 640 SL	LAB 1000	LAB 660	LAB 680	LAB 1500
<b>Device configuration</b>					
Door opening	Vertical sliding down	Vertical sliding down	Hinged	Hinged	Vertical sliding down
Stainless steel door	-	-	-	-	-
Stainless steel door with glass window	-	-	•	•	-
Full glass door	•	•	-	-	•
Double door pass through version	-	◦	-	-	-
Light inside the chamber	◦	◦	◦	◦	◦
Nr. of independent levels of the washing and/or drying system	4	4 <sup>1</sup>	3	5	8 (4x2)
Nr. of levels that can be used simultaneously	3	3	3	4	6 (3x2)
Triple stage water filtering system	•	•	•	•	•
Preheating boiler for DI water	-	-	◦	◦	-
Preheating tank DI water	◦ <sup>2</sup>	◦	-	-	◦
Adjustable water temperature (up to 93°C)	•	•	•	•	•
Double PT 1000 probe for temperature check	•	•	•	•	•
<b>Chemicals</b>					
Std equipment of chemical dosing pumps: nr.	2	2	2	2	2
Additional chemical dosing pumps: up to nr.	4	4	4	4	4
Storage of chemical tanks, nr. and capacity lt/Gal US (capacity may vary depending on option configured in the washer)	2 10/2.64	3 10/2.64	3 10/2.64	3 10/2.64	2 10/2.64
<b>Drying system</b>					
Forced hot air drying system	◦	•	◦	◦	◦
Pre filter 98%	◦ <sup>3</sup>	◦ <sup>3</sup>	◦ <sup>3</sup>	◦ <sup>3</sup>	◦ <sup>3</sup>
Hepa H14 air filter	◦	◦	◦	◦	◦
Steam condenser	◦	◦	◦	◦	•
<b>Control system and traceability</b>					
LCD display control panel, 40 programs (20 pre-programmed, 20 user defined)	-	-	•	•	-
Touch screen display, 65 programs	• <sup>4</sup>	• <sup>4</sup>	-	-	• <sup>5</sup>
RS232	-	-	•	•	-
USB port	-	-	◦	◦	•
Ethernet connection	•	•	◦	◦	•
External printer	-	-	◦	◦	-
Integrated printer	◦	◦	◦	◦	•
<b>Utilities</b>					
Electrical feeding	•	•	•	•	•
Steam feeding	◦	◦	◦	◦	◦
Standard electrical connection, others available upon request	400V 3-+N 50Hz	400V 3-+N 50Hz	400V 3-+N 50Hz	400V 3-+N 50Hz	400V 3-+N 50Hz
Total power kW	14.5	26	20	20	22

• = Standard    ◦ = Optional    - = Not available

Notes:

1. On removable cassettes;
2. Preheating tank. Single pass final rinse option on LAB 640;

3. With forced hot air drying system;
4. 5.7" color touch screen display
5. 7" Industrial PLC with colour touch screen HMI



## Capacity and dimensions

Device	Overall dimensions WxDxH mm/inches			Volume lt/ft <sup>3</sup>	Basket volume lt/ft <sup>3</sup>	Chamber dimensions WxDxH mm/inches		
LAB 640 SL	765	800	1975	350	280	636	650	825
	30 1/8	31 1/2	77 3/4	12.4	10	25 1/16	25 8/16	32 1/2
LAB 1000	1100	960	1940	500	350	715	815	940
	43 5/16	37 13/16	76 3/8	17.7	12.4	28 1/8	32 1/16	37
LAB 660	1140	930*	1975	600	430	710	810	1060
	44 7/8	36 5/8*	77 3/4	21.2	15.2	27 15/16	31 3/8	41 3/4
LAB 680	1140	930*	1975	600	430	710	810	1060
	44 7/8	36 5/8*	77 3/4	21.2	15.2	27 15/16	31 3/8	41 3/4
LAB 1500	1350	840	1985	568	369	1160	580	845
	53 1/8	33 1/16	78 1/8	20	13	45 11/16	22 13/16	33 1/4

\*External with door opened +845mm/33 1/4"



## How to configure your washing cart?

Example of configuration of a washing cart for simultaneous washing of  $\varnothing 70\text{mm}/2\frac{3}{4}"$ ,  $\varnothing 85\text{mm}/3\frac{3}{8}"$ , and  $\varnothing 100\text{mm}/3\frac{15}{16}"$  glassware by the use of C057002 cap screws for closing injection nozzle seats.

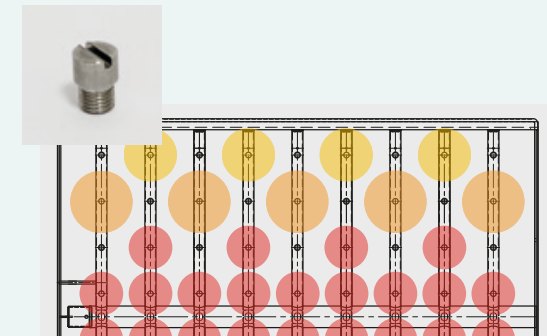

# Supports configuration

## Example of preconfigured supports



Bulb, graduated, Pasteur pipettes

Injection washing

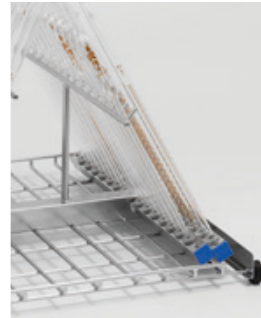

Immersion and flushing washing

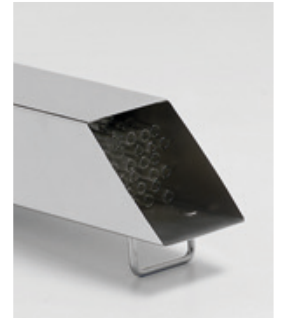

Beakers Jugs Mugs Buckets Jars Weighing bottles Funnels Powder funnels Imhoff cones



Test tubes



Evaporating dishes Weighing dishes Petri dishes Basins Trays



Erlenmeyer flasks Bottles Beakers Weighing bottles



## Example of configurable supports

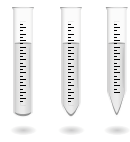

Test tubes and vials



Low capacity volumetric flasks



Centrifuge tubes

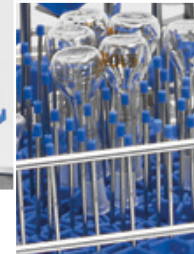

Volumetric flasks narrow neck

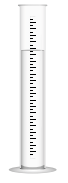

Graduated cylinders



Wide neck bottles



Erlenmeyer flasks wide neck

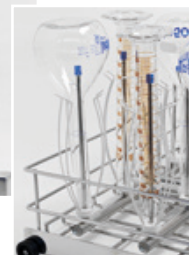

Erlenmeyer flasks narrow neck



Flat or round bottom flask narrow neck



Funnels

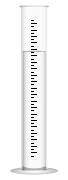

Graduated cylinders



Erlenmeyer flasks wide neck



Wide or narrow neck bottles



Weighing bottles

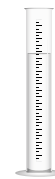

Graduated cylinders



Imhoff cones

# Washing carts selection, injection nozzles, accessories and components

Each customer is given the possibility to fully customize the cart frame by using different nozzles and/or accessories.



## Nozzles are available in different height sizes

According to the glassware shape and dimension, nozzles should be chosen in order to have 10/90 mm clearance from the nozzle final tip and the glassware bottom.

Some kind of nozzles are endowed with adjustable spring retainer.

Spring retainers allow to place glassware of different heights on the same nozzle.

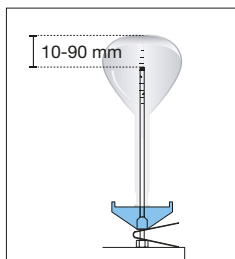

## Nozzle dimensions

The "critical" dimensions to be considered in choosing the suitable nozzle are the following:

**E** dimension:

for the correct coupling nozzle/glassware and the check of the distance nozzle/glassware.

**D** dimension + clearance:

for the compatibility check washing machine/positioning level.

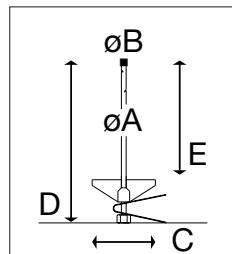

		C057911	C057912	C057914	C057915	C057917*	C057913	C054946
<b>A</b>	mm in.	8 5/16	8 5/16	8 5/16	8 5/16	8 5/16	8 5/16	8 5/16
<b>B</b>	mm in.	17 11/16	17 11/16	17 11/16	17 11/16	17 11/16	17 11/16	17 11/16
<b>C</b>	mm in.	87 3 7/16	87 3 7/16	105 4 1/8	105 4 1/8	105 4 1/8	105 4 1/8	105 4 1/8
<b>D</b>	mm in.	255 10 1/16	320 12 5/8	445 17 1/2	420 16 9/16	420 16 9/16	320 12 5/8	300 12 5/8
<b>E</b>	mm in.	235 9 1/4	300 11 13/16	425 16 3/4	400 15 3/4	400 15 3/4	300 11 13/16	280 11 1/32

\* Radial holes on the total height nozzle



## Injection nozzles types

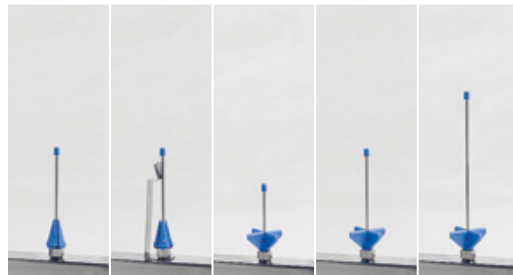

**C054542 C054543 C054953 C054544 C054546**

	A	B	C	D	E
mm in.	2,5 1/8	2,5 1/8	15 9/16	85 3 3/8	80 3 1/8
mm in.	4 3/16	4 3/16	32 1 1/4	50 2	80 3 1/8
mm in.	2,5 1/8	2,5 1/8	32 1 1/4	85 3 3/8	65 3 1/8
mm in.	2,5 1/8	2,5 1/8	32 1 1/4	105 4 1/8	85 3 3/8
mm in.	2,5 1/8	2,5 1/8	32 1 1/4	105 4 1/8	85 3 3/8



**C054548 C054549**

	A	B	C	D	E
mm in.	4 3/16	4 3/16	54 2 1/8	135 5 5/16	105* 4 1/8*
mm in.	5 3/16	5 3/16	54 2 1/8	155 6 1/8	110* 4 3/8*
mm in.	4 3/16	4 3/16	54 2 1/8	155 6 1/8	110* 4 3/8*
mm in.	4 3/16	4 3/16	54 2 1/8	155 6 1/8	110* 4 3/8*
mm in.	4 3/16	4 3/16	54 2 1/8	155 6 1/8	110* 4 3/8*



**C054550 C054551 C054552**

	A	B	C	D	E
mm in.	6 1/4	6 1/4	75 2 15/16	195 7 11/16	150* 5 7/8*
mm in.	10 3/8	10 3/8	75 2 15/16	220 8 11/16	180* 7 1/16*
mm in.	6 1/4	6 1/4	75 2 15/16	275 10 3/4	235* 9 1/4*
mm in.	6 1/4	6 1/4	75 2 15/16	275 10 3/4	235* 9 1/4*
mm in.	6 1/4	6 1/4	75 2 15/16	275 10 3/4	235* 9 1/4*

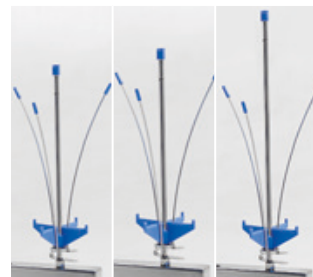

**C054553 C054554 C054555**

	A	B	C	D	E
mm in.	6 1/4	6 1/4	75 2 15/16	195 7 3/4	165 6 1/2
mm in.	10 3/8	10 3/8	75 2 15/16	220 8 11/16	180* 7 1/16*
mm in.	6 1/4	6 1/4	75 2 15/16	275 10 13/16	235* 9 1/4*
mm in.	6 1/4	6 1/4	75 2 15/16	275 10 13/16	235* 9 1/4*
mm in.	6 1/4	6 1/4	75 2 15/16	275 10 13/16	235* 9 1/4*



**C054947 C054559 C054560**

	A	B	C	D	E
mm in.	6 1/4	6 1/4	flex	175 6 7/8	-
mm in.	10 3/8	10 3/8	flex	195 7 11/16	-
mm in.	6 1/4	6 1/4	flex	220 8 11/16	-
mm in.	6 1/4	6 1/4	flex	220 8 11/16	-
mm in.	6 1/4	6 1/4	flex	220 8 11/16	-

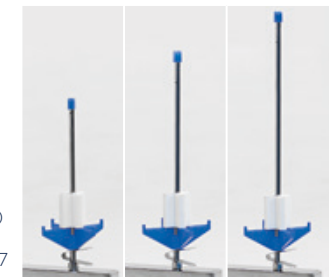

**C054556 C054557 C054558**

Bottle support  
ø 28mm  
(1 1/8 in.)  
code  
C054037

	A	B	C	D	E
mm in.	6 1/4	6 1/4	75 2 15/16	195 7 11/16	150* 5 7/8*
mm in.	10 3/8	10 3/8	75 2 15/16	220 8 11/16	180* 7 1/16*
mm in.	6 1/4	6 1/4	75 2 15/16	275 10 13/16	235* 9 1/4*
mm in.	6 1/4	6 1/4	75 2 15/16	275 10 13/16	235* 9 1/4*
mm in.	6 1/4	6 1/4	75 2 15/16	275 10 13/16	235* 9 1/4*

\* indicates the maximum dimension for the height regulation of nozzles with spring.

# Accessories, inserts and components



**C61** Insert with 28 spring hooks for laboratory glassware



**C63** Net basket  
mm 120x120x120  
4 3/4"x4 3/4"x4 3/4"  
C64 cover for C63



**C1150** Adjustable height net cover for 121 positions test tubes washing carts (i.e. C1148, C1149)  
dim. 365x365x255 h mm  
14 3/8"x14 3/8"x10 1/16" h

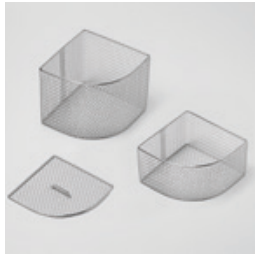

**C68** mm 100h/3 15/16" h  
**C69** mm 130h/5 1/8" h  
**C70** mm 200h/7 7/8" h

**C77** Cover for C68, C69 and C70



**C97** 26 positions insert for Petri dishes



Net cover for 121 positions test tubes wash carts (i.e. C421, C441, C723, C804.....)



**C1061** 248x248x250 h mm / 9 3/4"x9 3/4"x9 13/16" h

**C1086** 248x248x175 h mm / 9 3/4"x9 3/4"x6 7/8" h

**C1105** 248x248x45 h mm / 9 3/4"x9 3/4"x1 3/4" h (C1105 to be laid directly on top of the test tubes)

Usable height reduced by 40mm (1 9/16")



**C86** net separator for 1/4 net basket

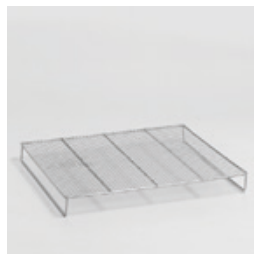

**C788** Support grid ensuring a flat surface on a C736, usable height reduced by 50mm (2")

# Complete your laboratory with Steelco Sterilizers

## VS L Series

Efficient, versatile, and intuitive, Steelco laboratory autoclaves are developed to sterilize glassware, liquids, and tools, ensuring maximum performance and energy efficiency.

Up to 22 standard chamber sizes with a volume from 110 litres (4 cu ft) to 9,070 litres (320 cu ft) are available with pressure vessel and relief valves that are PED and/ or ASME marked or according to the directives of the country of destination.

VS L sterilizers are engineered to offer best-in-class solutions to reduce energy and water consumption to give users the lowest operating costs per load. ECO water-saving options provide unrivaled efficiency levels, reducing water consumption to nearly zero depending on the chosen model and options.

Our experienced layout design team is always available to support you in planning new facilities or upgrading existing laboratories. Our process engineering team can develop cycles specifically to meet your needs at best.





**Miele** Group  
Member

# Customization. Innovation. Excellence.

## STEELCO - Miele Group Member

Headquarters:  
Via Balegante, 27 - 31039  
Riese Pio X (TV) - Italy  
Ph. +39 0423 7561  
Fax +39 0423 755528  
info@steelcogroup.com  
[www.steelcogroup.com](http://www.steelcogroup.com)

### Branches:

STEELCO AUSTRIA  
Wals-Siezenheim, Austria  
info-at@steelcogroup.com

STEELCO BELGIUM  
Mollem, Belgium  
info-be@steelcogroup.com

STEELCO BENELUX  
Vianen, Netherlands  
info-benelux@steelcogroup.com

STEELCO CHINA  
Shanghai, China  
info-cn@steelcogroup.com

STEELCO FRANCE  
Paris, France  
info-fr@steelcogroup.com

STEELCO GERMANY  
Gütersloh, Germany  
info-de@steelcogroup.com

STEELCO HUNGARY  
Budapest, Hungary  
info-hu@steelcogroup.com

STEELCO MEA  
Dubai, UAE  
info-mea@steelcogroup.com

STEELCO MEXICO  
CDMX, Mexico  
info-mx@steelcogroup.com

STEELCO NORDIC  
Glostrup, Denmark  
info-nordic@steelcogroup.com

STEELCO NORGE  
Nesbru, Norway  
info-no@steelcogroup.com

STEELCO SPAIN  
Madrid, Spain  
info-es@steelcogroup.com

Contact our distributor

**ANIMA LAB**

info@animalab.eu · www.animalab.eu

